



ARRAY SOLUTIONS
2611 N. Beltline #109
Sunnyvale, TX 75182

www.arraysolutions.com

Vector Network Analyzer 2180

© April 23, 2012

Table of Contents

Quick Start.....	3
Calibration.....	10
Colors & Styles.....	17
Commands.....	20
Parameter Buttons.....	37
Data Averaging & Trend.....	37
Data Display	42
Custom Calibration.....	44
Data Referred to Antenna.....	49
Line Extension.....	51
Markers.....	53
Smith charts.....	57
VNA2180 Principles of Operation.....	58
Measurement of Crystal Parameters.....	62
Frequency Source.....	66
Port B Functions.....	67
Appendix 1 – Specifications.....	70
Appendix 2 – Complex Numbers.....	71
Appendix 3 – Hot keys.....	75
Appendix 4 –USB Operation.....	76
Appendix 5 - Expansion Port.....	77
Appendix 6 – Battery Operation.....	81
Appendix 7– Saving Screen Shots.....	82
Appendix 8 – Configuration File.....	83
Appendix 9– Component Test Fixture.....	89
Appendix 10 - External Control.....	91
Appendix 11 - Voice Output.....	92
Appendix 12 – Band Skipping.....	93
Appendix 13 - DSP Filters.....	94
Terms and Conditions.....	98

Update History:Oct 24, 2011 : version 535

Cal Port B by itself.
Alternate between two graph sizes.

June 21, 2011: version 530

Added **TDR** function. - select mode from main menu at top of screen.
Added **Cursor Data** window - position the cursor and press numeric 1 or 2.

Both swr rulers are displayed on the Smith charts.

Phase delay for Port B can be compensated (page 68).

Output amplitude can be set in constant frequency mode (page 67)

Delay smoothing can be a percentage of full scale (page 25)

External control procedure has been revised (Appendix 10)

The Band Scan procedure has more detailed information (page 29)

Quick Start

Loading the Software:

The VNA2180 software does not require a formal installation procedure. It does not interfere with any other programs or the registry on your computer.

- 1) Create a folder or a subfolder on any convenient hard drive. For example, “C:\VNA2180” (use any name you like).
- 2) Insert the CD labeled “VNA2180” in the CD drive or download the latest version of the program from: <http://www.w5big.com/vna2180.htm>.
- 3) If you are using a CD, copy all the files on the CD to the folder you just created for the analyzer software and documentation. Be sure to clear the Read-Only status bit on the files.

If you downloaded the program from the web, unzip the files in your VNA folder. These do not have the Read-Only bit set.

4) The file labeled “VNA_xxx.exe” is the executable file. It is ready to run without going through an installation process. When later versions of the program are released, the number “_xxx” will be different. All versions of the analyzer program can reside in the same folder at the same time, although separate folders can be used to keep the files organized. The older programs with the lower numbers will not interfere with the newest version, so they do not have to be deleted. If there is any question about the performance of a new version, you can switch back immediately to an earlier version for a comparison.

If you want to make a shortcut icon for your desktop, right click on the VNA_xxx.exe file and select “create shortcut” from the dropdown menu. Drag the shortcut to your desktop or task bar. Right click on the icon to bring up the renaming option.

When the files are loaded from a CD, they may be flagged as “**read-only**”. In order for the calibration and initialization data files to be updated properly, the “read-only” flag must be cleared. Highlight all the files in the folder by pressing **control-A** and then right-click to see the properties of the files. If the “read-only” property box has a checkmark, uncheck it and then click “Apply”. This will remove the read-only flag on all the highlighted files. None of the files in the folder need to be read-only.

For the latest software version check: <http://www.w5big.com/vna2180.htm>

For operating tips or to post your own ideas, check: <http://www.w5big.com/forum.htm>

HARDWARE CONNECTIONS:

Plug in the DC power supply (11 to 15V at 500 ma recommended) and insert the connector into the jack on the rear panel of the analyzer. Note: if a power supply is included with your VNA2180 from Array Solutions, it is for **120VAC only**. A **global power supply** for operation on 240V can be ordered as an option along with your VNA2180.

Press the power switch. The Red LED's will blink a few times to indicate the controller program is running. The Red LED's then remain off except when a scan is being performed.

To turn off the power, press the power switch again. The red LED's will come on until the power switch is released. If the analyzer does not receive a command from the PC for 10 minutes, it will power down automatically *if it is in the AutoPwrOff mode*. The AutoPwrOff mode can be turned on/off with a menu selection under the **Setup** tab at the top of the screen. This is useful when operating with a battery.

When using the VNA2180 with a new antenna system, check the **AC and DC voltage** between the **antenna ground** and the **ground used for the VNA2180 and the PC**. This voltage should be less than 1V. A balanced antenna should have a DC connection to ground through a balun or RF choke on one side (or both sides). Of course there should **always** be a large resistor (or balun) connecting both leads of any antenna to a ground path in order to drain off static electricity. This protects people, test equipment and capacitors that are used in the antenna tuner.

NOTE: Before connecting a transmission line to the input of the VNA2180, be sure to momentarily short its pins together to drain off any static charge that may be present. Also, be sure there is **no DC voltage** on the antenna. If there is DC, use a blocking capacitor between the VNA2180 and the antenna input.

Antennas and transmission lines can have enough static charge to damage sensitive electronic equipment. This can happen even when there is no rainstorm in the area. A strong wind can generate static charge. So can just flexing a coaxial cable by rolling it up or unrolling it, even if there is no antenna connected to it.

An antenna or a component to be measured should not be connected or disconnected from the analyzer while a test is in progress. A test is in progress when the RED LED's are on.

Be sure the maximum input voltage at the DC power connector does not exceed 15 volts. The minimum input voltage required is 10.0 volts.

NOTE: Low cost power supplies that plug in the wall are usually not regulated and their maximum output when no load is connected may be several volts higher than their rated output. **Check the output voltage with no load to make sure it does not exceed 15 volts.**

Power supplies that operate on a wide input voltage range such as 120V to 240V use a switching regulator. Evaluate the measurement results to see if noise from the power supply may be a problem. For comparison, you can take some measurements while using a 12V battery and then with the AC power supply.

The VNA2180 can be operated on battery power for remote operation with a laptop computer. The current required is typically about 350 ma.

Batteries are not included with the VNA2180 but you can make a battery pack using any type of batteries you like. Disconnect diodes are included so an internal battery and the AC power supply will not interfere with each other. There is also a space for an optional resistor to use for trickle charging a battery, if desired. The main power on/off switch controls the battery power too, so the leakage current is less than one microamp when the VNA2180 is turned off. Refer to Appendix 5 and the Application-Help file for more details.

When using the VNA2180 to test a mobile antenna on a motor vehicle, it is better to use a separate battery and **not** the 12V battery in the vehicle. A small 12V gel cell (sealed lead acid) battery can be used for extended operating periods. This avoids the problem of sneak paths through the ground between the DC power input and the antenna ground connection. It will also help reduce measurement noise if it's necessary to run the engine while taking data (such as to operate the air conditioner). **If it's essential to get power for the VNA2180 from the vehicle, be sure to put 1 amp fuses in BOTH the +12V lead and the power ground lead.** A small voltage drop across the fuses will not affect the VNA2180 since the battery voltage is much more than the required minimum operating voltage. The laptop computer being used should remain **floating** for the best measurement accuracy.

PC INTERFACE CABLE:

Connect one end of the USB **cable** to the VNA and the other end to a USB port on your PC. You many need a new USB driver. (Many computers will already have the appropriate driver.) The USB interface chip used in the VNA2180 is made by FTDI (www.ftdichip.com). The chip is called FT232R and the recommended driver for several versions of Windows is 2.04.16. A link to it is on this page:
<http://www.ftdichip.com/Drivers/VCP.htm>

If your computer is connected to the internet at the time you first plug in the USB cable, Windows XP and Vista may be able to find the driver automatically on the internet. This may take two or three minutes.

After the driver is installed and it has assigned a port number to the VNA2180, use the Windows Device Manager to find the comm port number. Click "**Start**" in the lower left corner of the screen, then click "**Control Panel**", "**System**", "**Hardware**", "**Device Manager**". The comm port number will be shown in a list of i/o ports similar to this:

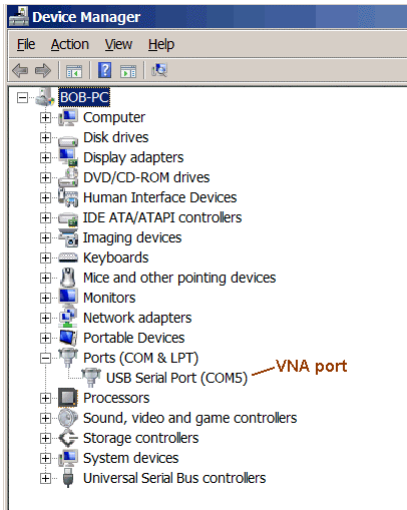

Under the VNA **Setup** menu tap at the top of the VNA program screen, click on **Enter Comm Port** and enter the port number that was assigned by Windows. This number will be saved in the setup file called *VNA_xxx.ini*. The default comm port number may be 6 or 5.

The usb interface can be customized for improved performance. Double click on the line that says "USB Serial Port (COMxx)". The **General Properties** dialog will pop-up:

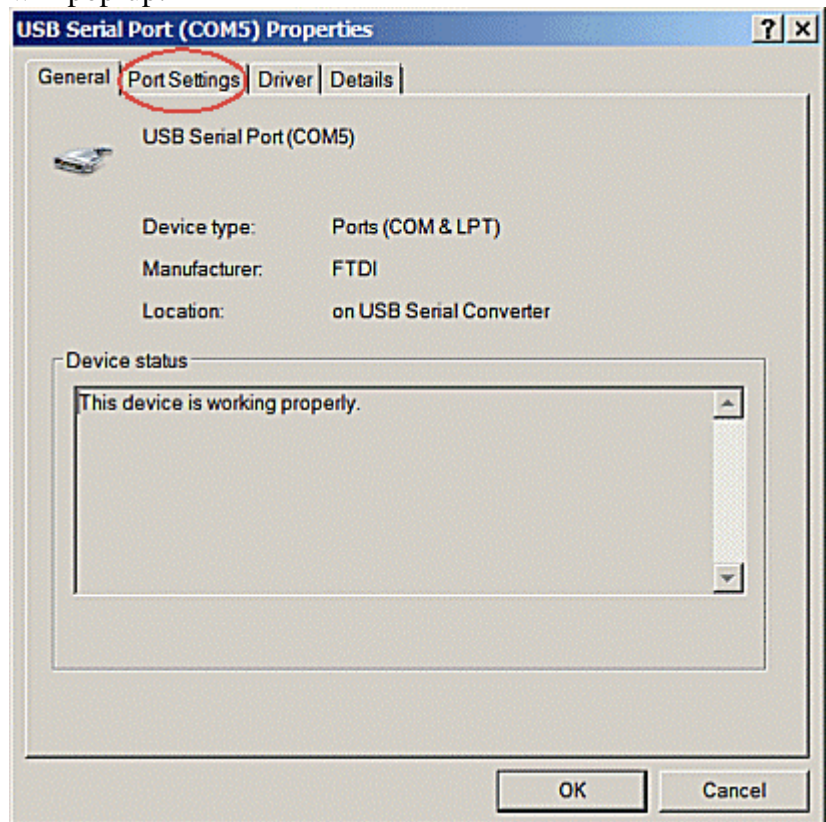

Click on the tab that says "Port Settings".

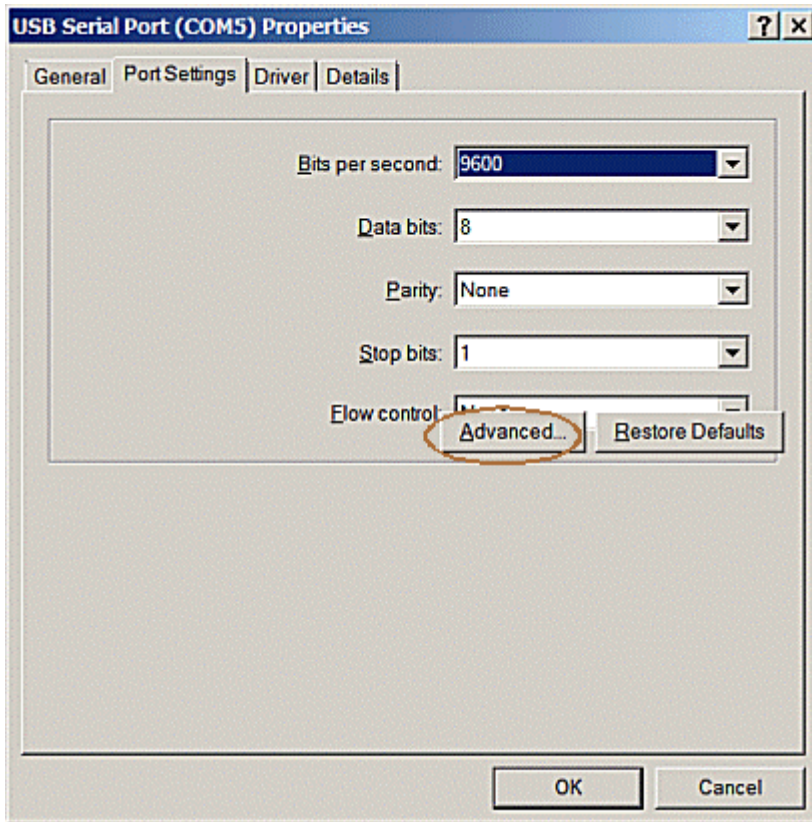

Change the **Bits per second** to **430000**.

Click on the button labeled "Advanced" (this button may be overlapping the Flow Control edit box). Click on the outer edge of the Advanced button.

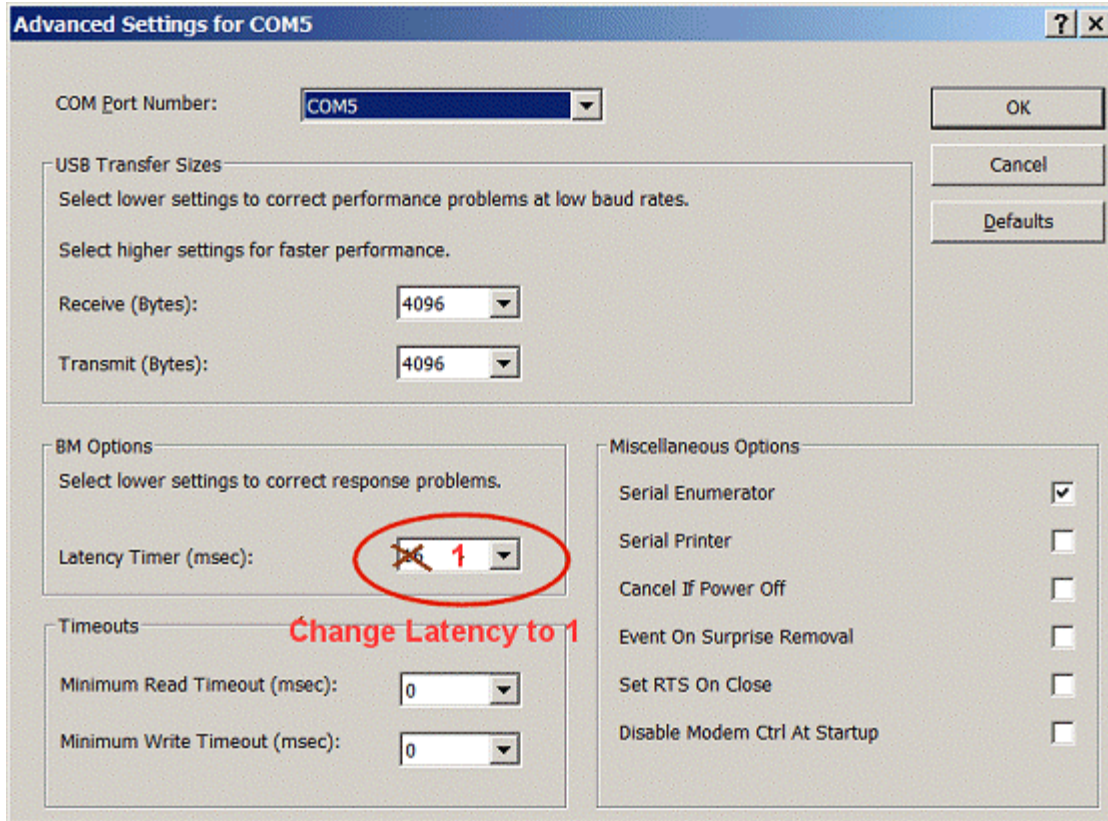

The COM Port Number can be changed, if desired. **Make a note of this number**; this is the value that will be entered into the VNA program for the comm port. Change the parameter called "Latency Timer" from 16 to 1. This will speed up the communication.

The VNA2180 program has been used with Windows 2000, XP, Vista and Windows 7. It can probably be used with a MAC, like the AIM4170. For more information about setting up a USB interface, see Appendix 4.

Initial Operation:

Launch the VNA_XXX.exe program. The first time the program is run, you will need to enter the comm port. Click **Setup** and **Enter Comm Port**. Then close the program and restart it.

You will see a graph similar to this:

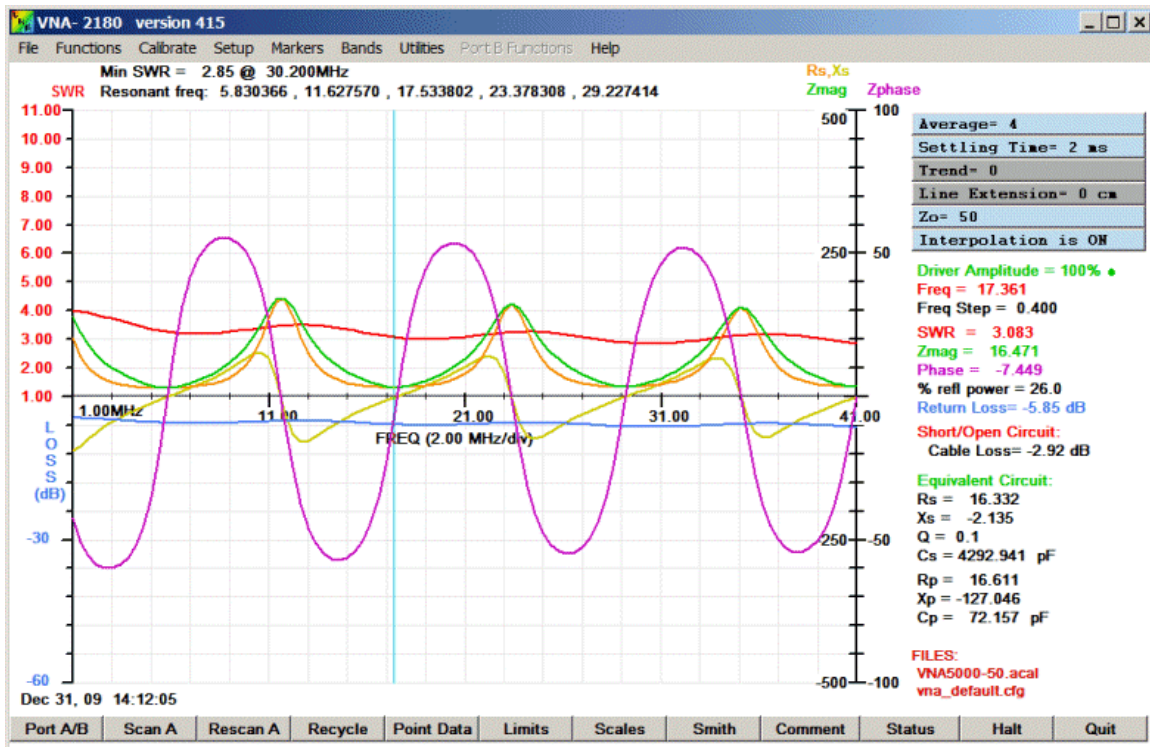

This is the last scan that was taken before the program was closed. Each time the program starts, it restores the previous scan.

When the VNA2180 is present, it must be turned on **before** the PC program is launched. If the PC program starts when the VNA2180 is not connected and powered up, the program will automatically enter the **DEMO mode**. In the demo mode you can load graphs that have been stored and measure the parameters with the cursor.

Calibration

The VNA2180 has **no internal adjustments**. There are no trim pots or caps inside. All the calibration is done with the following software procedure.

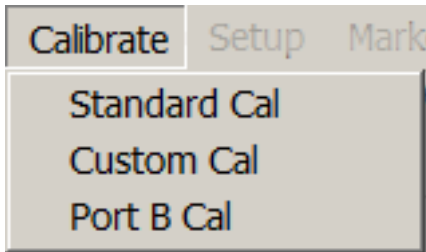

Click on the **Calibrate** menu. Click **Standard Cal** to calibrate the full range of the VNA with data taken at 0.2MHz increments.

For a **Custom Calibration**, you can specify the start and stop frequencies and the delta frequency between cal points.

Port B Cal allows calibrating Port B without having to repeat the calibration procedure for Port A.

A message box will appear near the center of the screen, as shown below:

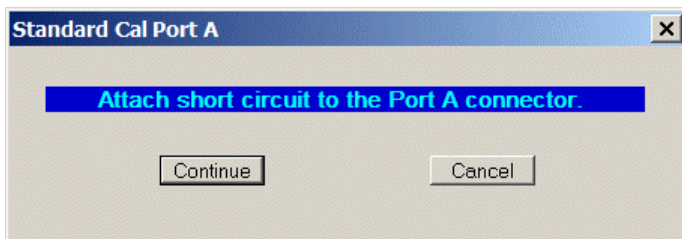

Attach the connector with an internal short circuit (this is included with the VNA2180, it's labeled "**short**" and the label is green).

After the short circuit is in place, click **Continue**.

The program will run for a few seconds to take several readings of the **short circuit**. Numbers in the upper left corner of the screen will show the progress.

Sometimes it is useful to calibrate with a short adapter cable that makes connections to the load that will be analyzed. The effect of this adapter can be canceled by placing the calibration loads (short, open, resistor) at the far end of the adapter.

When calibrating with a coax stub connected to the VNA Port A, the impedance may appear to be significantly different from a short circuit at 1 MHz and a message will

appear asking if this is a valid condition. If the connections are correct and you really do want to continue with the special external hardware hooked up, click YES. Otherwise, click NO to abort the cal procedure. Then, after connecting the desired load, restart the calibration.

After the short circuit calibration is complete, a message box will appear as shown below:

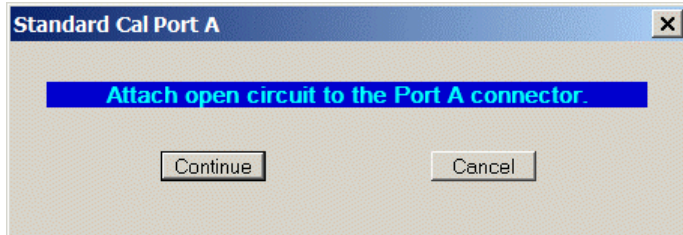

Replace the short circuit with an **open connector** (red label) and then click **Continue**. It is important that an open male connector be attached to Port A. If the connector is not attached, the load capacitance at Port A will be off by a few picofarads and the calibration will be less accurate.

The program will run for a few seconds to take several readings of the **open circuit**.

For the best accuracy, especially at VHF frequencies, use an **open connector** of the same type that is used for the **short circuit**. This allows the program to compensate for the stray capacitance of the connector itself. For example, 3 pF of stray capacitance due to a BNC connector represents a reactance of about 1K ohm at 50MHz which will appear to be in parallel with the load. This will seriously affect readings at higher frequencies if it is not properly compensated. Therefore, the three calibration devices (open, short, resistor) should be carefully constructed so they have similar stray capacitance and inductance which will be cancelled out by the calibration procedure.

NOTE: If you are using an adapter, leave it on the Port A connector when calibrating with all three loads. In this way, the capacitance of the adapter itself will be included in the calibration process.

For example, If you want to use a BNC-to-binding post adapter, calibrate the short circuit with a **jumper wire** across the binding posts. Then remove the wire and calibrate the open circuit condition with the adapter still attached. A metal or carbon film resistor with leads can be used for the calibration resistor. The actual value of this resistor is not critical as long as it is accurately known. 50 ohms to 500 ohms can be used. Measure it with your ohmmeter and enter the appropriate value when prompted. This procedure cancels the stray capacitance of the adapter and you can get accurate readings of discrete components attached to the binding posts.

The calibration procedure can also cancel the effect of a piece of coax that is used as a jumper to connect the VNA2180 to the load. In this case, the open, short and standard resistor are connected to the far end of the jumper.

After taking several readings of the open connector, the program will prompt for the standard resistor with a typical value between 50 ohms and 500 ohms.

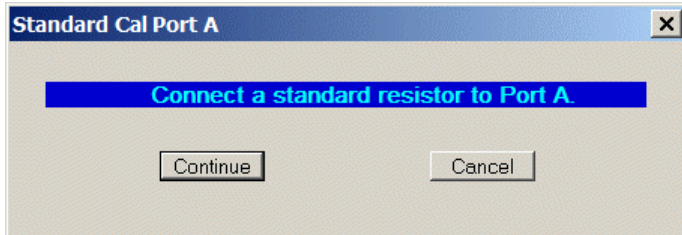

The value of this calibration resistor does not have to be the same as the Z_0 reference value that is used for calculating parameters, like SWR or return loss. Generally speaking, small resistors can be used when measuring relatively low impedances, like antennas, and larger resistors may give better results when measuring large impedances, like the common mode impedance of baluns.

This resistor should be mounted on a connector like those used during the open and short calibration steps. The exact value is not critical. Enter the value you measured with a digital ohmmeter and click Continue. If you are using the cal resistor (yellow label) that is included with your VNA, the number printed on it should be entered. If you have a different cal standard, use that value.

After calibrating Port A, there is an option to calibrate Port B. If you don't plan to use Port B, this step can be bypassed by clicking "No". (*Port B can be calibrated later without having to repeat the calibration procedure for Port A.*)

To calibrate Port B, attach a short jumper coax from Port A to Port B. The length is not critical (unless you're interested in precise phase measurements). The length of this cable (or cables) will be the zero-length reference between Ports A and B. Some appropriate jumpers are included with the VNA accessories.

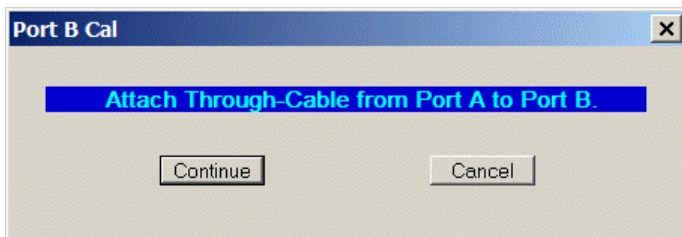

NOTE: when using coax jumpers to connect the ports of the VNA to the circuit under test, the cables should be oriented in a consistent manner. The ends of the cables should be marked so they can always be connected the same way they were when

calibration was performed. For this purpose you can mark one end with colored tape, paint or finger nail polish.

If the VNA2180 will be used to check a high gain amplifier, an external attenuator can be calibrated in the path from Port A to Port B to avoid overloading the input to Port B. The input to Port B should not exceed 1V peak (about +10dBm). The output of Port A when connected directly to Port B for calibration is +7dBm. The input impedance of Port B is nominally 50 ohms with a return loss greater than 30dB. (SWR < 1.07)

After the cal procedure is complete, the Red LED goes off and the prompt for an optional **comment** appears. This optional comment will be saved with the cal file and can be read later in the **Status window**. It can also be viewed in the cal file itself with any text editor (such as Notepad). After entering the comment a request for the calibration data file name appears. A separate folder can be used for cal files, if desired.

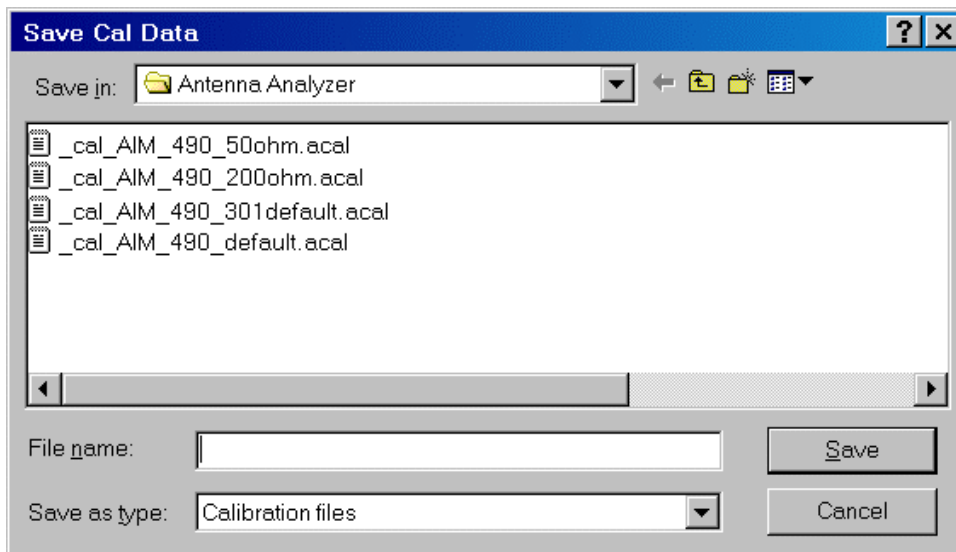

Enter the name of the calibration file and click “Save”. There is no restriction on the name of the cal data file. Its extension is automatically set to .acal (“**port A cal**”). Any of these cal files can be recalled later using the menu option “**File**” → **Load Cal File**.

Then the **cal complete** message box is displayed with a summary of the calibration parameters.

Each time the VNA2180 program starts, the last calibration file that was used will be read to restore the cal data. *The cal data can be transferred to other computers if desired.*

Each VNA2180 has an **ID number** associated with it. This ID number is attached to each calibration file so they will not be used with the wrong VNA. This is important when several VNA’s may be in use in the same work area. This ID number is placed in the cal file automatically and no additional user input is required. The VNA’s ID number can be seen by clicking “Help” -> ”About” or clicking the ”Status” button at the bottom of the screen.

This completes the calibration procedure.

For a quick test, connect the **calibration resistor** to the Port A connector and click the **SCAN A** button in the lower left corner of the screen.

The Red LED's for Ports A and B will come on while the scan is in progress. A blue bar will move across the top of the graph as the scan progresses. Port B provides a **50 ohm termination** for a filter when scanning the filter's input impedance with Port A.

You will see a set of traces (similar to the picture below). This shows the VNA2180 is functioning.

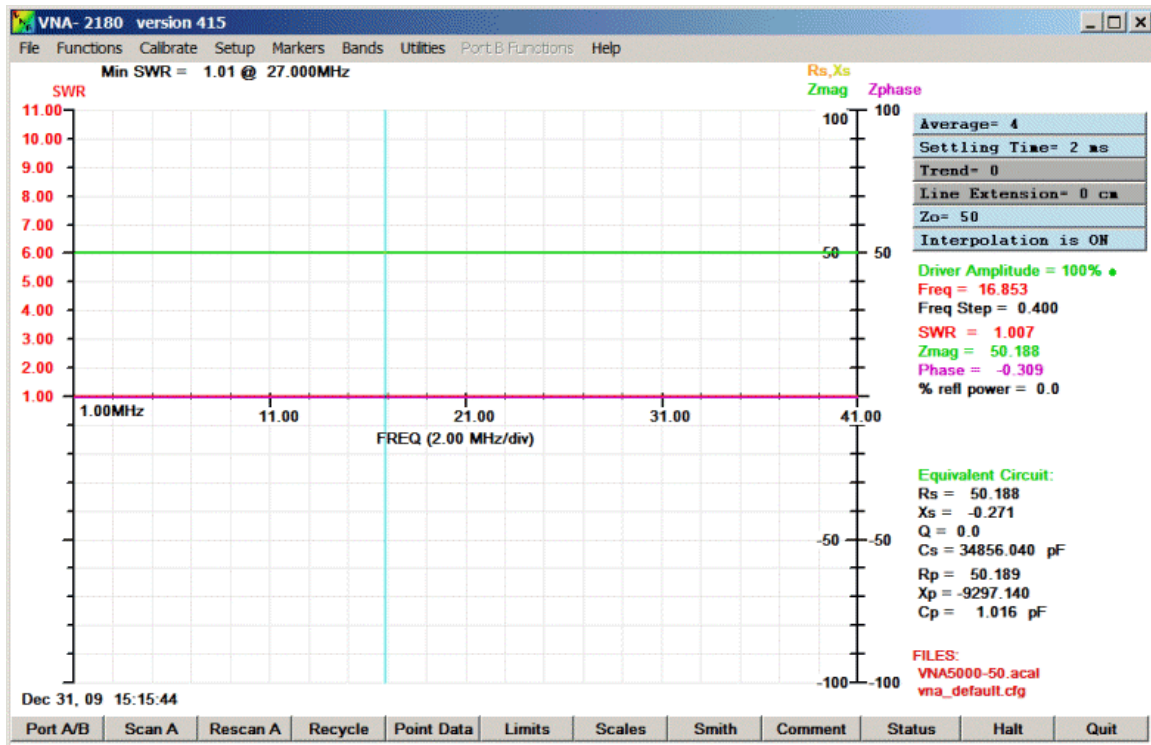

Scan using a 50 ohm resistor for a test load.

The **size of the graph** can be changed by dragging the corner of the window with the mouse. While resizing is in progress, the width and height are displayed in the upper left corner of the window. After setting the size you like, click anywhere inside the window to redraw the graph. The default graph size can be restored by opening the **"Setup"** menu and then clicking **"Default graph size"**. This default graph size is specified in the **config file**. It can be customized by the user using the **Edit Config File** feature under the **Help** menu.

Graph sizes down to 640x480 (or smaller) can be used. The ratio of the width to the height is not critical. When using a larger monitor, the graph size can be increased, if desired. The size of the Smith chart can be controlled independently of the graph size by specifying a ratio with respect to the nominal Smith chart size. This is called the **"Smith**

chart size factor" in the config file. It can be made smaller (down to 0.5X) or larger (up to 3.0X). Both Smith charts will be the same size. When using a small graph, it may be better to make the font size smaller too. This is specified in the config file.

Port A on the VNA2180 works very much like the AIM4170. Most of the first section of this manual is derived from the AIM4170 manual. *Some of the screen shots used to illustrate the first section of the manual for Port A are from scans made with the AIM4170 or AIM430.* When measuring antennas and components, Port A will be used alone. In this mode, the connection to Port B is not important and Port B does not have to be calibrated. Port B will provide a 50 ohm termination for two-port circuits, like filters, even if Port B is not calibrated.

Port B can be calibrated by itself by clicking on the **Port B Cal** menu item. This assumes a cal file for Port A is already loaded in memory. The new cal data for Port B will replace the old data for Port B, if any, and the new file will include cal data for both Ports A and B. This feature is useful when the external connections to Port B change, such as different cables or different adapters for a new application. The calibration for Port A does not have to be repeated, thus saving time in creating a new cal file.

Colors & Styles

The color of each trace corresponds to the color of the label at the top of the Y-axis. The default color for **SWR** is **RED** and this scale is on the left side of the graph. On the right side the magnitude of the **impedance** is the inside scale and the trace is **GREEN**. The **reactance** is in **YELLOW**, also on the inside scale. Reactance and impedance use the same scale. Reactance can be positive (inductive) or negative (capacitive). The **phase angle** of the load impedance is plotted in **MAGENTA** and this scale is on the outside of the right hand vertical axis. These default colors can be changed in the configuration (*.cfg) file if desired.

The colors can be selected from the **Setup** menu:

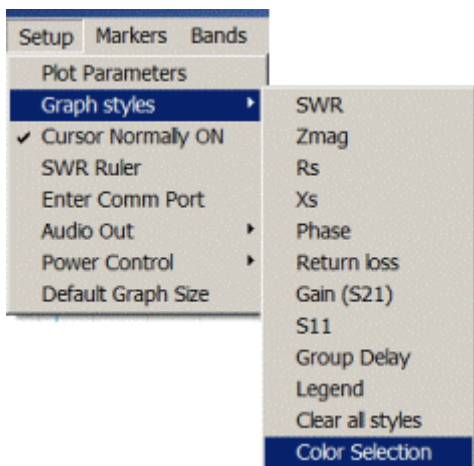

Click **Color Selection** to bring up the color selection palette:

The colored buttons show the colors for either the primary scan traces or the rescan traces. Click the desired button to fine tune the color for a trace. The default colors in the config file can be restored all at one time by clicking the "Restore Default Colors" button. The new colors will be saved in the *.ini file when the program is closed.

The default colors in the config file can be changed manually by using the **config file editor**, which is accessible on the **Help** menu. The three numbers on each line in the config file color section are the values for **red, green and blue** shown in the color palette when you click "**define**



custom color". The numbers should be entered in decimal format.

The **width of the trace lines** can be specified in the config file. The default width is "2". For some situations, such as presentation slides, a wider line may be desired. A separate config file can be set up so you can switch between display options quickly with the **Files->Load config file** menu.

Each trace can be plotted in a different **style** to make it easier to visualize. This is particularly helpful when graphs are printed in **black and white**. The menu is shown below:

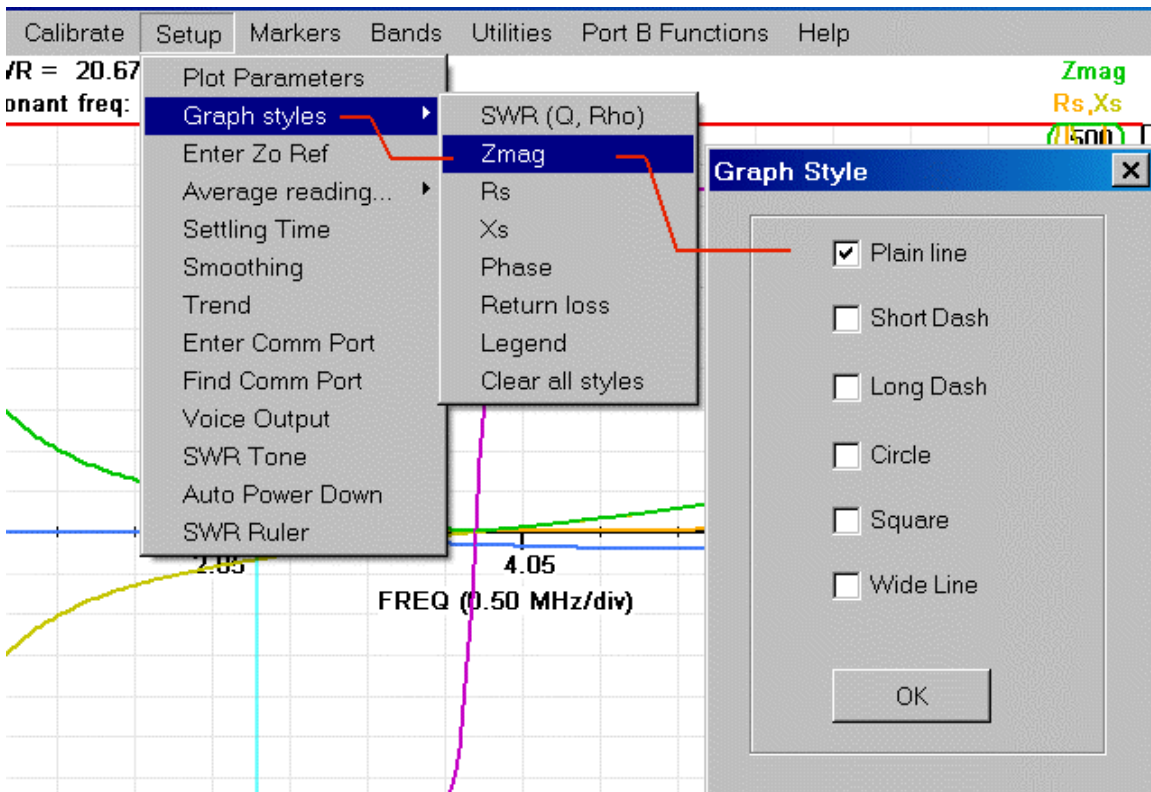

This example shows some of the styles:

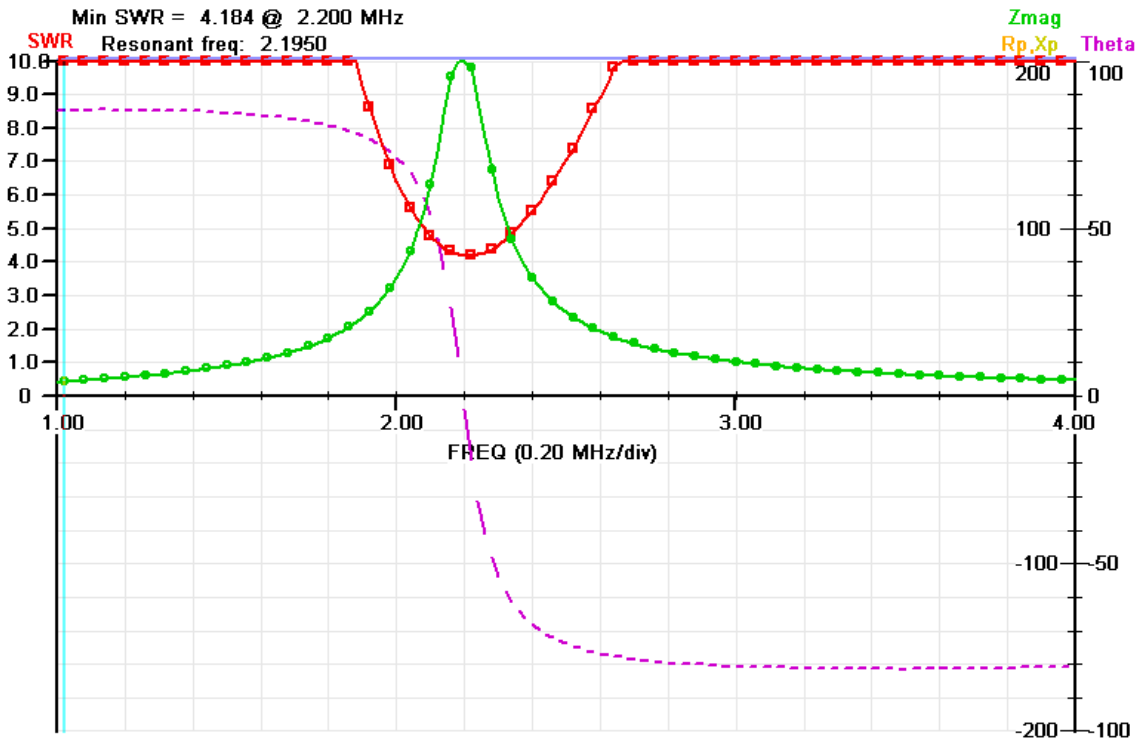

When a new style is selected, the graph is redrawn to show its effect. The styles are saved in the *.ini file. The style only applies to the image on the screen; the raw data is not affected. The style option does not apply to the **rescan** traces. The traces for a **rescan** are plotted with plain lines in the specified color.

A legend showing the graph styles presently in effect can be displayed by clicking “**Legend**” on the **Graph Styles** sub-menu. The legend window can be repositioned so it doesn’t interfere with the plot.

Commands

The most common commands use the buttons along the bottom edge of the screen:

PORT A/B – Select either Port A or Port B for the following commands. This button will be grayed out if Port B is not calibrated.

SCAN A/B (S=hotkey)– Starts the scan between the specified frequency limits: Start_freq to the End_freq. (see **Limits** button below.) Each time the scan button is clicked, the graph is cleared and the new scan data replaces the previous data in memory. While Port A is being scanned, both of the red led's are on indicating that Port B also is active. In this way, Port B provides a 50 ohm termination while testing the Zin (*or S11*) of a filter connected to Port A.

RESCAN A/B (R=hotkey) – A new scan is started but the graph is **not** cleared. This makes it easy to see the before and after effects of changes to an antenna (or any component or filter being measured). The new data replaces the previous data in memory but both graphs can be viewed simultaneously. RESCAN can also be used to overlay new data on top of a scan that was loaded from a data file. See “File -> Load” below.

RECYCLE – Scanning is repeated over and over until the RECYCLE or the HALT button is clicked. This makes it possible to continuously view the results while adjusting an antenna or tuning a stub. The resonant frequency is displayed above the graph and it's updated after each scan during recycle. The scan limits can be adjusted to narrow the scan range for a faster update rate.

A flag in the config file determines if the graph is erased before each scan. The default is *don't erase*.

While Recycle is in progress, you can click Rescan to get a new trace in a contrasting color. This can be useful to see where the present scan is after the varying data has formed an envelope on the graph.

POINT DATA (D=hotkey) - Measure the impedance or transmission at a specified frequency. The measurement can be a single-shot reading or repeated several times per second until the point data window is closed. Click the “Tune” button to start the repetitive mode. As its name implies, the Tune mode has been found to be very useful when adjusting an antenna tuner or a filter. This avoids stressing the power amplifier when the antenna is mismatched and it eliminates interference to others since the VNA2180 output power is less than 10 milliwatts (10 dBm).

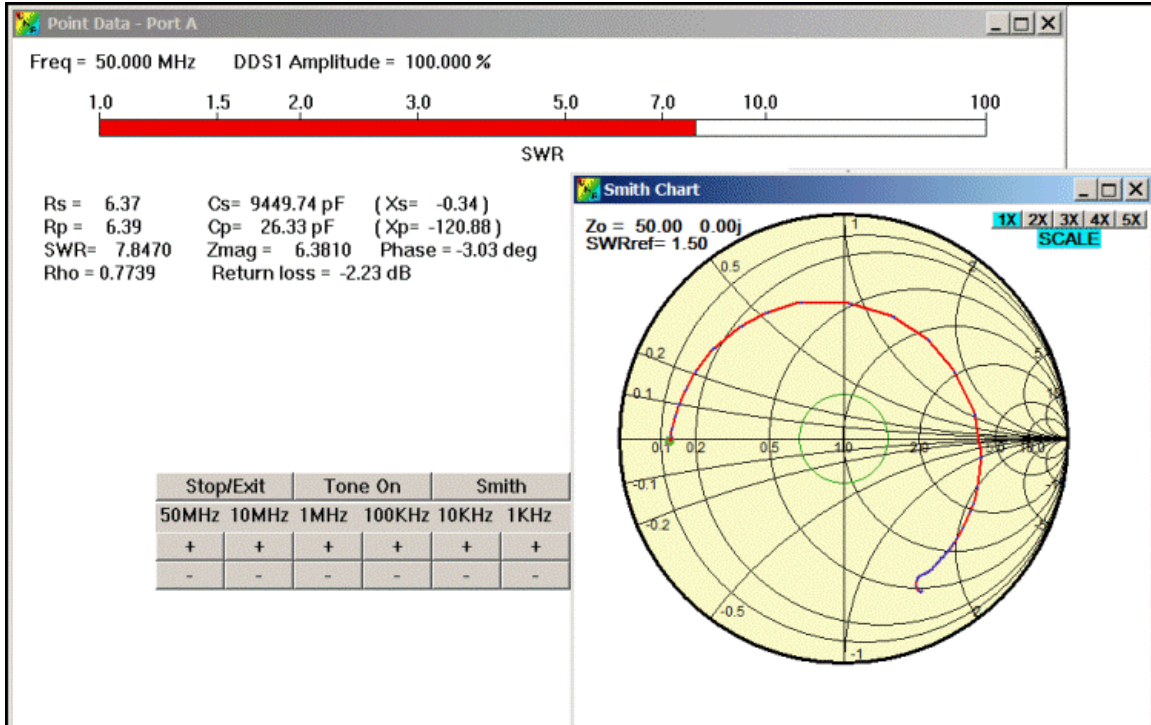

In the **tune mode**, a set of buttons appear in the data window to allow the **test frequency** to be incremented or decremented. The point data window display is shown below.

If the **Smith chart** button is clicked, the impedance can be plotted dynamically while adjustments are made.

While in **Tune Mode** a tone related to the SWR can be played through the PC speaker to assist in making adjustments without watching the monitor. Click the button labeled "Tone On" to start the tone. The parameters of the tone can be changed using the setup routine called "**SWR Tone**" under the **Setup** tab on the main menu at the top of the screen.

SWR can be sounded out verbally. See the Setup menu to enable this function. The swr tone or speech output can be played over an extension phone or cell phone while making adjustments to an antenna.

LIMITS (L)– When this button is clicked, a dialog box, shown below, pops up for entering the **start** and **stop** frequencies and the size of the frequency increment (**step**) between measurement points. The **start** and **stop** frequencies range from 5KHz to 180MHz.

The limits can be entered in either of two formats:

1. Start and Stop frequencies or
2. Center frequency and Span.

The span is the total interval between the start and stop frequencies.

The data on both sides of the dialog box are equivalent. One format may be more convenient than the other, depending on the application.

For example, to scan the 40-meter band, you might enter 6.9MHz for the Start frequency, 7.4MHz for the Stop frequency and 0.01MHz for the frequency Step (the spacing between measured points). This would result in a scan of 50 points across the band. The maximum number of scan points is 20,000 and the minimum number is 5. Frequency values can be in **KHz** instead of MHz if the number is followed by a **K** or **k**.

For band pass filters it is sometimes more convenient to enter the scan limits as a **center frequency** and **span**. For example, when measuring a 10MHz filter with a bandwidth of 10KHz, the center frequency would be 10MHz and the span could be 50KHz (+/- 25KHz either side of the center frequency) to include the attenuation band. Low frequencies can be followed by a **K** or **k** to indicate kilohertz.

There is an option to begin the plot at **zero** rather than at the specified Start Freq. This makes the plot easier to read in some cases. The scan will still begin at the specified Start Freq which cannot be less than the minimum frequency of the instrument (5KHz). For example, if you want to scan from 1MHz to 20MHz, the graph will be numbered starting at 1 and go up to 21. This makes the numbers on the X-axis: 1,6,11,16,21. However, if you start at 1MHz, stop at 20MHz and select the “**start plot at zero**” option, then the X-axis will be labeled: 0, 5,10,15,20 and the actual scan will be from 1MHz to 20MHz.

If you enter a number greater than or equal to 20 in the **Step box**, it is assumed to be the number of data points, not the step size in MHz. The frequency interval between data points will be determined by dividing the total scan range by that number. For example, if you enter Start=1, Stop=2 and Step=100, the frequency spacing between points will be 0.01MHz (10KHz). The result is the same as entering Step=0.01 or Step=10k.

Note that when using the cursor to read out numeric data (discussed in detail later), the displayed values are **interpolated** between the measured values. Therefore, in some cases it may be desirable to use a larger frequency step for a **faster scan rate**. You can still read the parametric values at intermediate frequencies with the cursor.

In some special cases, the raw data may change so rapidly between the calibration points (which are multiples of 0.2MHz) that interpolation is not accurate. This can happen when a sharp filter is included in the calibration path. In this case, it may be better to use only the calibration points for measurements. This can be specified by unchecking the interpolation box. Note that a new interpolation procedure has been implemented in version 420, so the interpolated data will be accurate over a wider range of applications than it was before.

When **custom cal** is used, the step size between calibration points can be small so that interpolation is not needed in critical applications. When a Custom Calibration file is being used, the banner at the top of the scan limits window will say "Custom Cal" (*instead of "Standard Cal", as shown in the figure above*).

SCALES - When this button is clicked, a dialog box pops up for entering the full-scale values for the plotted parameters.

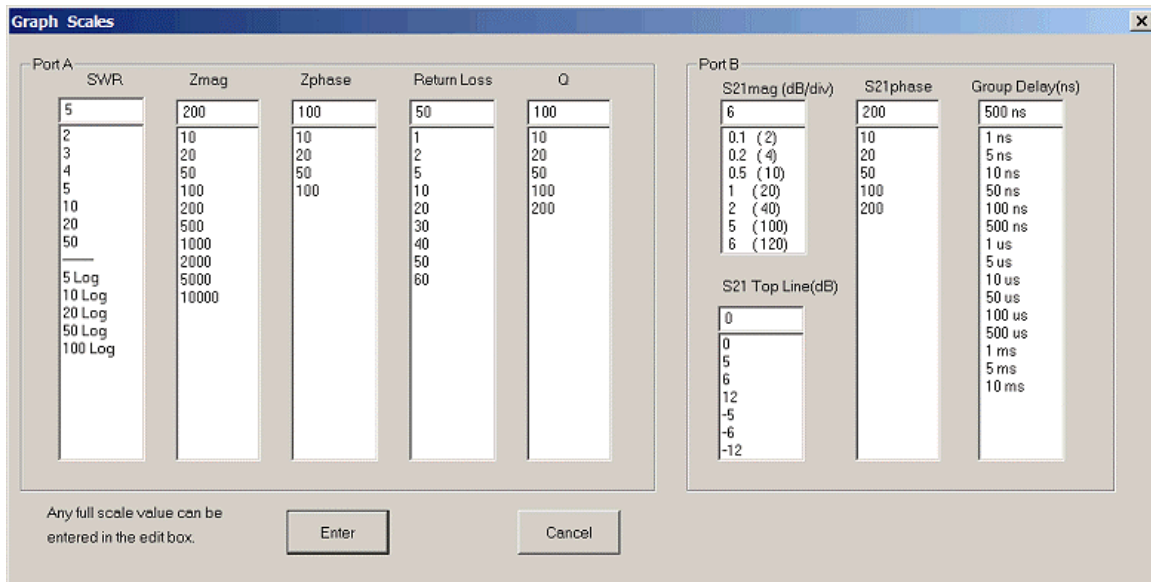

Port A					Port B		
SWR	Zmag	Zphase	Return Loss	Q	S21 mag (dB/div)	S21 phase	Group Delay(ns)
5	200	100	50	100	6	200	500 ns
2	10	10	1	10	0.1 (2)	10	1 ns
3	20	20	2	20	0.2 (4)	20	5 ns
4	50	50	5	50	0.5 (10)	50	10 ns
5	100	100	10	100	1 (20)	100	50 ns
10	200		20	200	2 (40)	200	100 ns
20	500		30		5 (100)		500 ns
50	1000		40		6 (120)		1 us
	2000		50				5 us
5 Log	5000		60				10 us
10 Log	10000						50 us
20 Log							100 us
50 Log							500 us
100 Log							1 ms
							5 ms
							10 ms

Any full scale value can be entered in the edit box.

Enter Cancel

SWR can be plotted on a linear or a log scale. An arbitrary value for the full scale can be entered in the edit box. If this value is followed by the **letter L**, the scale will be

logarithmic. The horizontal line for SWR=1 can be specified in the config file. Default is one major division above the horizontal axis.

Note that **Rs**, **Xs** and **Zmag** are plotted on the same scale. If the actual measured value is off the scale (flat line at the top of the graph), the value readout by the cursor is still valid since it uses the raw data stored in memory. For example, you can set the Zmag scale to 500 ohms in order to see fine details but if the impedance actually goes up to 1600 ohms at some frequencies, the cursor can still read the true value and display it in the data window.

*Full scale values that are not on the list shown here can be entered **manually** by typing in the edit box at the top of each list. For example, if you're measuring a 50 ohm dummy load, you can enter 60 for the full scale Zmag value to get better resolution than if the regular 100 ohm scale were used.*

Return Loss is plotted on a logarithmic scale in dB.

S21 is plotted on a log scale in **dB**. The first number in this box is the **dB/div** and the number in parentheses is the **full scale** value, which depends on the value of the **S21 Top Line**.

The value of **S21** that corresponds to the **top line** of the graph is entered in **dB**. This allows offsetting the plot of **S21** for the best resolution.

When you select new scale factors, the data from the last scan will be replotted using those scales.

Group Delay is the derivative of the phase shift through a network (e.g. a filter or transmission line) with respect to frequency. This corresponds to the time delay of a pulse through the network that would be observed with an oscilloscope. It also provides an indication of possible distorting in the network. Since Group Delay involves a derivative, it may be noisy. The amount of smoothing to use with this function can be specified by the "Delay Smoothing" parameter which is entered using a menu item under the "Port B Functions". Delay Smoothing is the number of samples by default. If the smoothing value is followed by a "%" or a "p", then smoothing is a *percentage* of full scale.

COMMENT – A dialog box pops up for you to enter a comment that will be displayed at the bottom of the graph. This is very useful for documenting the test conditions. This comment will appear in a screen capture or a screen print and it will be saved in the raw data file on disk if this scan is saved. Comments can also be added to a graph or a calibration file before it's saved.

STATUS – Display a window with the currently programmed parameters and file names.

HALT - While the scan is in progress, you can stop it by clicking this button. This is different from the QUIT button (shown below).

QUIT – This stops the program, saves the setup conditions (limits, scales, etc) and exits back to the Windows OS. When the program is launched again, the setup conditions and calibration data will be restored automatically.

Commands on the menu bar at the top of the screen

FILE:

Load Graph--

Load a raw data file from a previous scan. After this file is loaded, its data is just like the original scan. The cursor can be used to read out the numeric values.

When a data file is being displayed, the name of the file appears at the top of the graph.

After a graph is loaded, a new scan can be done and superimposed on top of the old data by clicking **Rescan**. This is useful for comparing before and after conditions when adjustments are made or when there may be a long term change in a component or an antenna. For example, you can see if your antenna is the same today as it was last week before the windstorm.

When a new graph is loaded from disk with the same limits as the present graph, it can be overlaid over the existing graph or it can replace the graph. Several graphs can be overlaid on each other.

Save Graph --

Save the raw data for the **last** scan that was done. If you clicked the RESCAN button, the data that will be saved is for the rescan. Even though the earlier scan is being displayed on the graph, its raw data was replaced in memory by the new data corresponding to last rescan command. The raw data is saved in a file with the extension .scn. Another file is created with the same name and the extension .csv. The .csv file has the same data in a format that can be read into a spreadsheet.

You can enter an optional comment when the graph is saved.

Swap Graphs --

Swap back and forth between the present scan and the previous scan. This function can be disabled by setting the “autosave” flag in the config file to zero (*default is enabled*).

Swap can also be done by pressing either the **up** or the **down arrow key**.

- Save Image Bitmap Save the current graph image to a file in the .bmp format. *If you just want to put the image on the clipboard to paste it into a document or another program, press Alt-PrintScreen instead of this function. Then paste it into another application using Control-V.*
- Print -- Print the graph on the system printer. Before printing in black and white, you can change the **graph display styles** to highlight each trace. This option is under the **Setup** menu.
- Load Calibration -- Load a calibration data file for a particular test setup or adapter. These files have the .acal extension.
- Load Config -- Any of several configuration files can be loaded. A selection window will show all the files in this folder with the .cfg extension.
- Quit -- Stop the program and exit.
This is the same as the QUIT button at the bottom of the screen.
- DC Power Off -- Remotely turn off the DC power to the VNA. *(It cannot be turned on remotely)*

FUNCTIONS:

- Distance to Fault -- Measure the distance to a cable open or short. This can also be used to measure the $\frac{1}{4}$ wave length frequency of tuning stubs. The impedance of the cable is also measured.
- For accurate results, it is important that the transmission be uniform, that is, it should not be made up of more than one type of cable.
- Refer to Antenna -- The impedance readings are transformed to be equivalent to readings directly at the antenna terminals. This procedure does not require disconnecting the transmission line from the antenna if you know the parameters of the coax.
- This should not be used if the transmission line is made up of several **different kinds of line**, such as, coax cable plus ladder line.
- For complex transmission lines, the **Custom Cal** procedure should be used. Custom Cal takes the place of what used to be

called “Ref to Antenna, Method A”. This new procedure is more accurate and more versatile. It’s discussed later in this manual.

Constant Freq --

Output a constant frequency that can be used as a test signal. Initial frequency accuracy is +/-30ppm. At 1MHz, the output amplitude into 50 ohms is about 700mV-rms (+10 dBm) and somewhat less at higher frequencies.

Band Scan --

Scan a band (particularly the AM broadcast band) to look for strong signals that may interfere with antenna measurements. The input signal is applied to **Port A**.

The scan start/stop limits are set using the same LIMITS button at the bottom of the graph window that is used for an impedance scan. The maximum **scan range** is 10MHz. The maximum **frequency step** is 2KHz, but a smaller step can be specified when the limits are set. The *recommended* maximum amplitude limit for an external signal is indicated by a red line, which corresponds to approximately **1.5V** peak. (This level corresponds to approximately +14dBm. It is not precisely calibrated.) Signals above this limit may result in less accurate impedance readings. It is not a rigidly fixed limit and in some cases, impedance readings may still be sufficiently accurate when signals above the red line are present.

The indication of weak signals can be improved by clicking the +12dB menu item. This adds 12 db to the reading at Port A. The total dynamic range for measuring the amplitude of external signals is approximately 50dB.

Measure Crystal --

Measure the parameters of a quartz crystal automatically. Details are in a later section. The crystal data can be saved in a file that can be imported to a spreadsheet program, such as Excel.

¼ Wave Stub --

Adjust a coax line to be 1/4 wavelength at a given frequency. The target frequency and the initial length (in feet) of the coax are entered in the dialog box. Then the graph runs in recycle mode and displays the amount of the line that needs to be cut off ("Excess Length") to reach the target frequency. A vertical red line on the graph highlights the target frequency. The magenta colored phase plot crosses the horizontal axis at the quarter wave frequency. There is more information in the **Applications** file under the **Help** menu.

Q Measurement –

This is used to measure the Q of **resonant circuits**. First, do a scan with the limits set to include the resonant frequency and

most of the response on either side of the resonant frequency. The step size is not critical but Q may change slightly with different step sizes. Experiment to see what is appropriate for your application. The resonant frequency does not have to be in the center of the graph.

Antenna Bandwidth- The bandwidth of an antenna at an SWR set by the SWR ruler is determined. First, enter the **SWR ruler** value with the **Setup** Menu. Then position the cursor near the valley of the SWR curve and click “Antenna Bandwidth”. The bandwidth and high/low frequencies will be displayed in a message box. Vertical lines will highlight the bandwidth region. For a multiband antenna, the bandwidth at each resonant frequency can be read by moving the cursor. The cursor does not have to be exactly at the minimum SWR point.

After positioning the cursor near the desired point, press the **left mouse button** to freeze the VNA cursor while moving to the bandwidth selection button on the **Function** menu.

Line Extension-- see the Line Extension section of this manual.

DSP Smoothing -- The scan data is processed to remove noisy data and the remaining samples are fitted with a smooth curve. This can be very effective for processing data from outside antennas where a strong radio station may be causing noise in a narrow frequency band, but the scan data is generally smooth.

For more information, see Appendix 13.

CALIBRATE:

Calibrate -- Calibrate the VNA2180 using open circuit, short circuit and resistive load. The calibration data is saved in a disk file that’s read each time the program is started.

An optional comment can saved with each cal file. The comment for the cal file presently in use can be seen in the Help->Status window.

The start, stop and delta frequency values can be user specified. The regular **short, open & resistor** loads are used. Long transmissions lines of any type can be calibrated at the far end so impedance data is then referred to the antenna terminals. It can also be used to calibrate out the effects of filters in the line. This function takes into account the length of the cable and also the loss.

SETUP:

- Plot Parameters -- Select the parameters that are plotted during a scan. The optional parameters for the A graph are: SWR , Q, Return Loss, Impedance magnitude and phase, Equivalent series or parallel load impedance.
- On the B graph the parameters are: S21 magnitude and phase, S11 magnitude and Group Delay. S11 when plotted on a dB scale is equivalent to the Return Loss.
- The last scan data will be replotted when new parameters are selected.
- Graph Styles -- A different style for plotting each trace can be specified to make the traces more distinctive. This is especially helpful when the graph will be printed in black and white.
- The colors for the primary scan and the rescan traces can be selected with the color palette. The default colors are saved in the config file. New colors are saved in the *.ini file.
- A **legend** can be displayed in the window to document the styles. This window can be **repositioned** to minimize interference with the graph.
- Cursor Normally ON If there is a checkmark on this line, the vertical cursor will move with the mouse and you can press the left mouse button to freeze it. If there is no checkmark, the action is reversed, you have to press the left mouse button to move the cursor with the mouse.
- (this function used to be in the config file, now it's more conveniently located on this menu.)*
- SWR Ruler -- A dashed horizontal line can be placed on the graph to help visualize when the SWR trace crosses a specified value. To turn this line **off**, enter a value of **zero**.
- This value is used when finding the antenna bandwidth.
- The ruler value corresponds to the **green circle** plotted on the Smith chart.

- Enter Comm Port -- Enter the comm port used for communication. Port values can be 1 to 65K. This is saved in the initialization file that's read each time the program is started.
- The comm port assigned by the PC's operating system can be found by using the Device Manager. See Appendix 4 for more information.
- AutoPwrOff This button enables/disables the automatic power down feature of the analyzer. The enable/disable flag is saved in the analyzer initialization data when you exit from the program (QUIT) and restored each time the program is started again. The timeout delay is 10 minutes.
- If you never use batteries, you may want to leave this feature turned off .
- Low current mode This reduces the dc current when the VNA is idle.
- Alternate Graph Size Switch graph size between the Default Width and Height specified in the config file and the size that was set with the mouse. This makes it easy to switch the graph size when creating documentation. *A relatively small graph generally looks better when pasted into word processor document.*
- SWR Tone -- While in the **Point Data "Tune Mode"** a tone related to the SWR can be output through the PC speaker. Lower pitch tones indicate lower SWR values. There are three parameters that control the characteristics of the tone:
1. Min Tone – a value from 1 to 50 determines the pitch for SWR=1.0. This value is typically 1.
 2. Max Tone – a value between 10 and 60 that determines the pitch for the highest value of SWR. This value is typically 50.
 3. Max SWR – the highest SWR that will cause a change in the pitch. SWR values higher than this generate a constant pitch. This value is typically 10.
- The SWR can also be sounded out verbally. The *.wav files for each digit are included. These can be easily customized.

BANDS:

- Highlight -- Highlight the frequency bands, such as the ham bands or AM or FM radio bands. These frequencies are specified in the configuration file (*.cfg). The start/stop limits do not have to be the actual amateur band limits. The highlight color can also be specified in the config file.
- The name of the band can also be user specified to be more descriptive. Refer to comments in the config file.
- Band Skip Scan only in the specified bands that are included in the present start/stop scan range and skip between bands. This makes it possible to scan several bands for a multiband antenna much more rapidly.
- 160..2 meters Click on the desired band to set the start/stop scan limits and the frequency step between measurement points. These limits can be changed in the configuration file.
- The **title** of the band can be changed in the **config file**. For example, bands can be assigned for specific radio stations and their call letters can be used for the title.
- Band A..D User specified band limits. Same as above.

- Port B Functions** These functions are only available when Port B is calibrated.
- Rulers -- Two horizontal rulers can be specified in **dB** to indicate **S21** levels. The numeric value can be positive or negative. The letters "dB" are not required. The rulers can be enabled/disabled without changing their values by clicking the check boxes.
- Ratios can be entered by following the number with the letter "x".
- For example: 0.5x will be converted to -6dB
- When a new value is entered for a ruler, it is automatically enabled.
- Delay Smoothing -- A **running average** is used to smooth the Group Delay data. This data tends to be noisy because it corresponds to the derivative of the phase angle. Larger values give more smoothing but the peaks will be flattened some and the trace will be shifted to the right.
- Filter Bandwidth -- After scanning S21 for a filter, its bandwidth can be found at the levels specified by the rulers. First, position the vertical cursor near the center of the response curve. (It does not have to be exactly in the center). Then click "**Filter Bandwidth**" and the bandwidth values at each level, along with the shape factor are displayed in a pop-up window. If you are not interested in the shape factor, only one ruler is needed.
- If the filter has ripple in the pass band, be sure the top ruler does not intersect the ripples.
- Averaging Weight -- During an S21 scan, the amount of averaging used changes dynamically as the signal level changes. When the signal is weak, more averaging is used to improve the signal to noise ratio. This weighting term controls how much the averaging changes. High weighting gives a better signal to noise ratio but the scan takes longer. Low weighting results in a faster scan.

UTILITIES:**L-C Matching****Networks** by WY2U

This program which is available on the web takes the impedance data (R and X) that is measured at the input end of the transmission line and calculates the L-C network required to transform it to the correct impedance (for example, 50 ohms) to match the transmitter. This can be used when designing a tuner to find the components to match an antenna over the desired frequency range.

When you click on this link, your computer must be connected to the internet. You may have to authorize the connection if you have a firewall program.

ZPlots by AC6LA

This program uses the data saved in the .csv file (by "File Save") to plot graphs for presentations. It features plot parameter selection and zoom capability. It can plot parameters that were not included in the original VNA plot and the plot range can be a subrange of the original data.

When you click on this link, your computer must be connected to the internet. You may have to authorize the connection if you have a firewall program. You can download the **Zplots** program to your computer and then run it off-line.

HELP:

- Help -- A help file pops up in the local browser. This is in html format and can be **edited by the user** if desired. The file name is "help_xx.htm".
- Applications -- Information about particular applications with the VNA. This is in html format and can be **edited by the user** if desired. The file name is "applications_xx.htm".
- Edit Config File -- The config file is opened in a text editor for making changes to parameters. After saving the file, be sure to close the VNA program and **restart** it to load the new config file.
- Check Program Update -- Click this link when you are connected to the internet to go directly to the program update page at w5big.com.
- About -- The present version of the programs in the PC and the controller are displayed. The url of the W5BIG website is also displayed.

Parameter Buttons

A set of button on the right side of the graph are used to display setup values. Click the button to make changes. If a parameter is set to a zero value or it has no effect, the button is grayed out.

Average= 4
Settling Time= 2 ms
Trend= 0
Line Extension= 0 cm
Zo= 50
Interpolation is ON

Average - Each data point is averaged by this value which can range from 1x (no averaging) to 256x. The values can be any integer, they don't have to be powers of 2 or 10.

Settling Time - after a new frequency is programmed to the DDS, there is a wait time for the circuits to settle. This can be set to zero. When scanning a very high Q circuit like a narrow band filter, this settling time may need to be made larger to let the circuit under test settle. Crystal filters may need 5 to 10 msec to settle.

Trend - A running average on the plotted data can help to display the trend of the data without the distraction of noise. This is useful when the data is changing slowly. For rapidly changing data, the peaks and valleys may be distorted.

Data averaging and trend:

These features can be used improve the presentation of the measurement data. Which one is better depends on the situation.

Averaging is the more fundamental. This causes several data readings to be taken at each test frequency and these readings are averaged. If there is random noise present, the noise is reduced by the square root of the number of readings. For example, an average of 4 readings will cut the random noise in half compared to no averaging at all. It's important to distinguish random noise (like noise in the output of a receiver) from systematic noise which may be due to some measurement inconsistency or some external noise source. Systematic noise will not be reduced by averaging. Up to 256 readings can be included in the average. Of course, taking more reading does make the scan slower.

Trend uses previous data points to predict the best value for the next data point. That is, if the data had an upward trend, it's expected this upward trend will continue. This makes the plot look much better in the presence of both random and systematic noise. The disadvantage is that data points are shifted slightly on the frequency axis, so phase zero crossings may be affected. The amount of the shift depends on the frequency step size used during the scan. A smaller step size results in a smaller phase shift. The effect of trend can be evaluated by doing a scan and then turning trend on (or off) and observing the results. The original raw data will be re-plotted with the new trend value. Compare the results both ways and decide if trend is applicable for a particular situation.

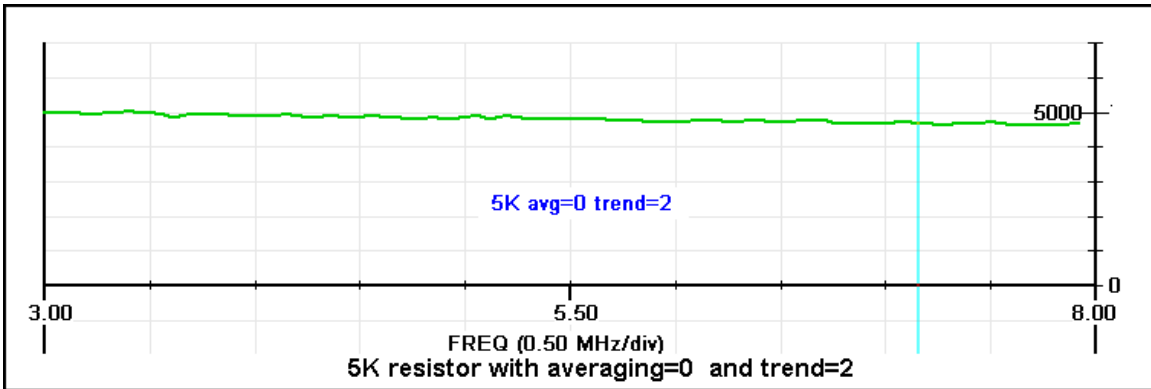
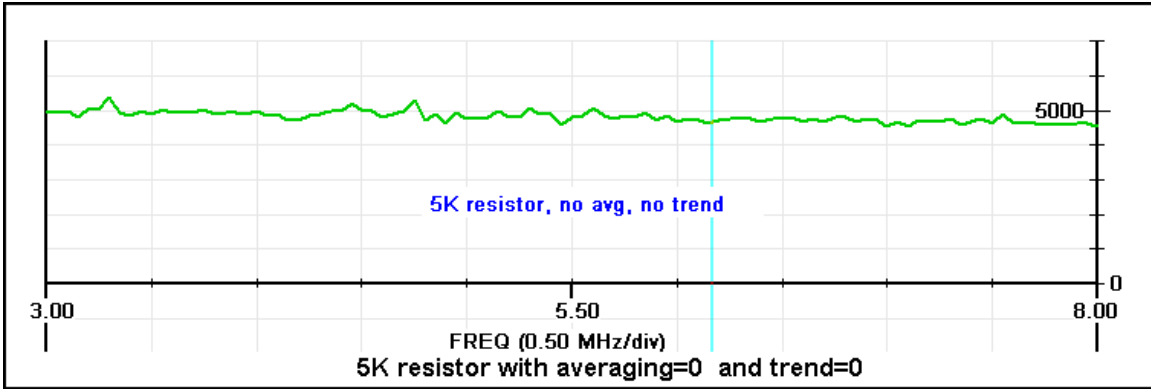

In this case the plot is so flat that any shift due to the trend function is not significant. The smoothing effect is noticeable and the scan time is less because only one reading is taken at each measurement point.

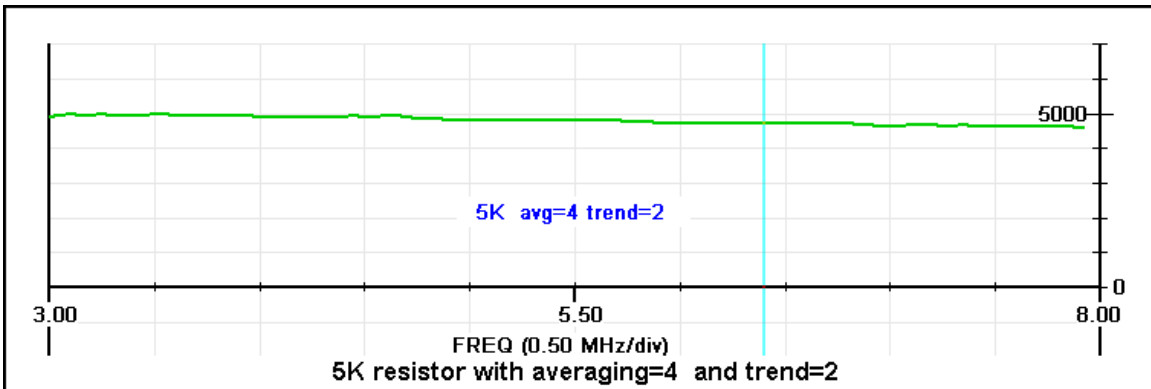

The smoothing effect is even better now with a combination of averaging and trend.

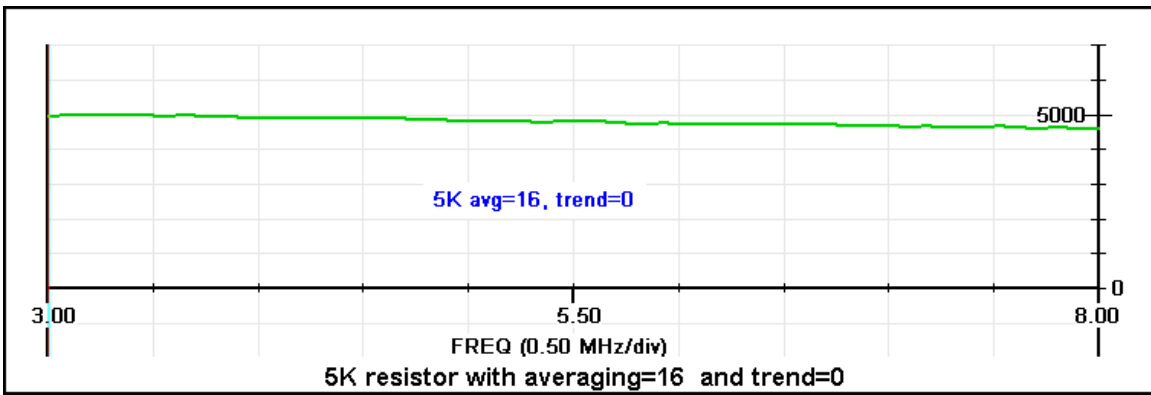
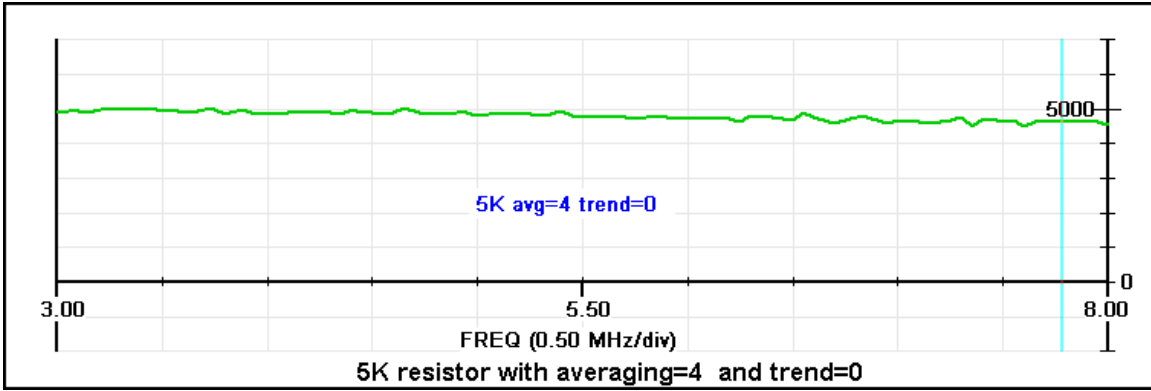

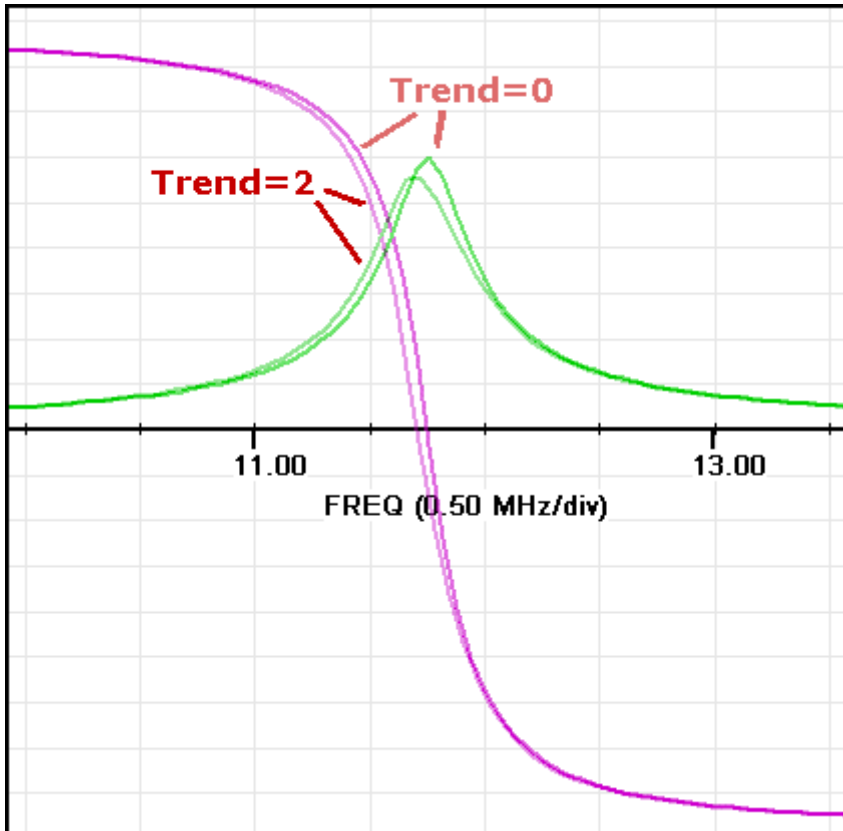

Effect of Trend on Resonant Frequency Readings

This scan of an L-C tuned circuit shows how trend can affect the phase shift and the peak reading. The phase shift can be either positive or negative, depending on the data. This phase shift can affect the reading for the resonant frequency of antennas or tuned circuits and also cable length.

The raw data for this example was not noisy, so it is better to leave Trend=0 when it is not needed.

For critical analytical situations where *maximum accuracy* is needed, set Trend=0 and use Averaging.

For faster scanning and better subjective appearance for presentations, use Trend or a combination of Averaging and Trend. Relatively small values of Trend, like 2 to 5, have been found to be very effective.

Line Extension - See the section on **Line Extension** in this manual.

Z₀ - The reference impedance value use to calculate SWR, Return Loss, and S11. This can be a complex number if desired.

Interpolation - Interpolation is used when measuring at frequencies that are in between the calibration data points. For example, when using Standard Cal, the cal points are on 0.2MHz intervals. There are cal points at 2.0, 2.2, 2.4, 2.6, etc. When making a measurement at 2.265 MHz, the cal data points at 2.0, 2.2 and 2.4MHz are used to find the equivalent cal data at 2.265 using parabolic interpolation. In some cases, the circuit under test may have such rapid changes in phase that interpolation is not accurate. In that case, the measurement points can be made to coincide with the cal points by turning interpolation off. If Standard Cal is being used, the measurement points will be on multiples of 0.2MHz increments. If Custom Cal is being used, the measurement points will be on multiples of the delta freq specified by the custom cal procedure. For example, if Custom Cal was done with 10KHz steps between points and you specify a scan step size of 25KHz without interpolation, the actual step size will be set to 20KHz. This makes the measurements coincide with calibration data points.

Data Display

After a scan (or after loading a file from disk), the mouse can move a cursor along the frequency axis and the numeric data for several parameters will be displayed continuously in a data window on the right side of the screen. An example is shown below:

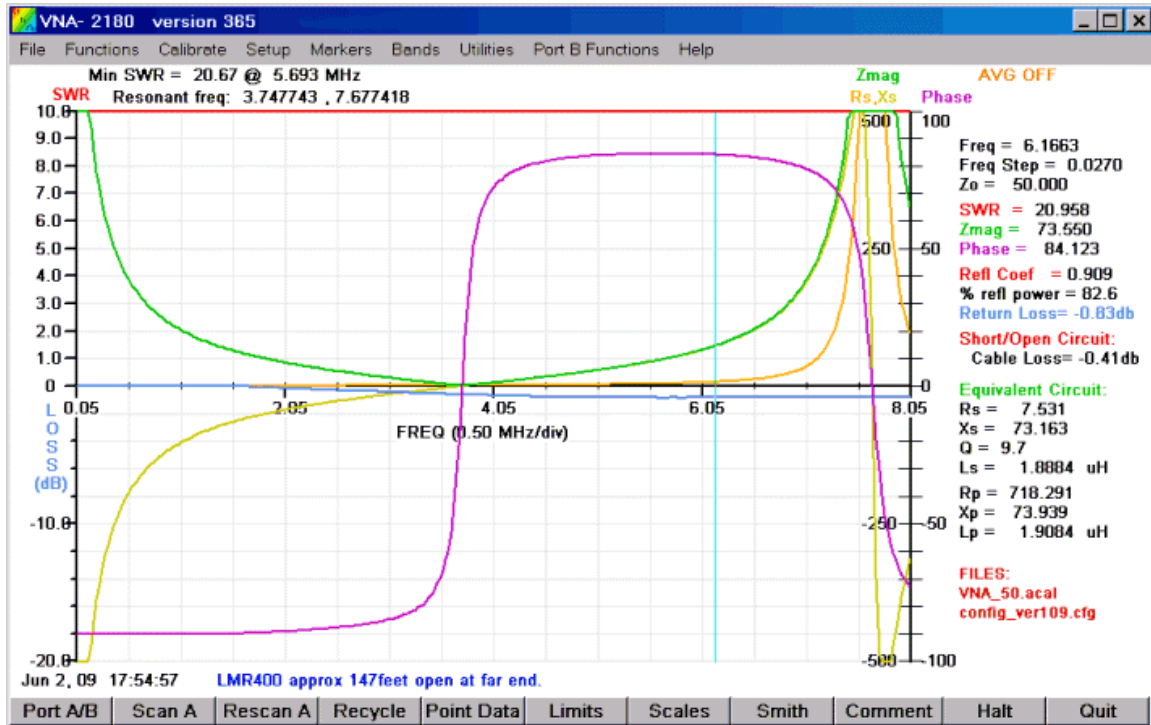

The light cyan vertical line is the cursor. It moves with the mouse whenever the mouse pointer is inside the graph area. In this example, the frequency is 6.1663 MHz. The frequency changes in 1-pixel increments due to the mouse resolution, so some specific frequencies may not be displayable. The data is interpolated between the actual data points that were recorded during the scan. The cursor can also be moved in small increments using the Left/Right Arrow Keys on the keyboard.

Normally the cursor moves whenever the mouse pointer is inside the graph area. The cursor movement can be stopped by pressing the **left mouse button**. This makes it easier to select items on the menu without disturbing the data being displayed on the right side of the graph.

*The action of enabling/disabling the cursor with the left mouse button can be reversed by clicking the **Setup** menu item called "Cursor Normally ON".*

Data in the window shows the characteristic impedance, Z_o , has been specified to be 50 ohms. The SWR at 6.1663 MHz is 20.958, $Z_{mag}=73.550$ ohms, and Phase= 84.123 degrees.

Component values for both a series and a parallel equivalent circuit are shown as R_s , L_s (series circuit) and R_p , L_p (parallel circuit). Note that when the phase angle is negative, the equivalent components, L_s and L_p , change to C_s and C_p automatically.

At the top of the graph in the main window, up to five resonant frequencies of the antenna are displayed. These are the frequencies where the phase angle passes through zero.

The names of the calibration and configuration files being used are shown in the lower right corner of the data window. The color used to display these file names can be selected in the configuration file.

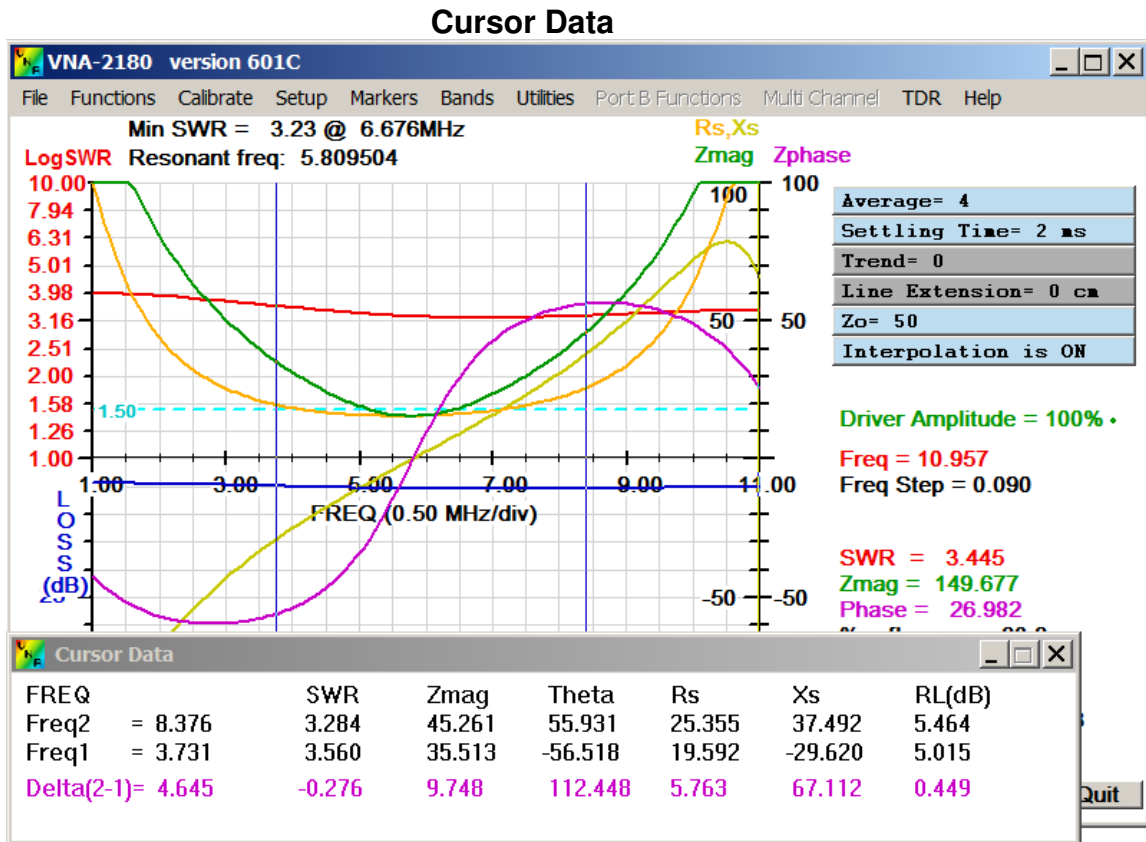

The data at two frequencies can be displayed along with their differences by pressing a numeric **1** for the first point, moving the cursor to the second frequency and then pressing **2** for the second point. This action can be repeated by moving to other points and pressing **1** or **2**. Data in the small window will be updated each time. The two selected frequencies are indicated by blue vertical lines on the graph. Close the data window by clicking the **x** in the upper right corner.

Custom Calibration

This specialized calibration procedure is useful for situations involving filters or long cables. For more routine work with physically small sockets, adapters, or short cables, the **Standard Calibration** procedure can be used.

The **custom calibration** technique allows the measurement reference point to be moved from the Port A RF connector on the front panel to the end of a transmission line and/or a filter. This has the advantage (compared to the standard cal procedure) of canceling the effect of complex transmission lines and filters so the data at the antenna can be determined more accurately. The custom cal routine can be used to calibrate long transmission lines or a relatively short line that may be used for an interconnection in a lab setup. This calibration process may take longer when a small delta-freq is used, but the scan rate is essentially the same using either standard or custom cal data.

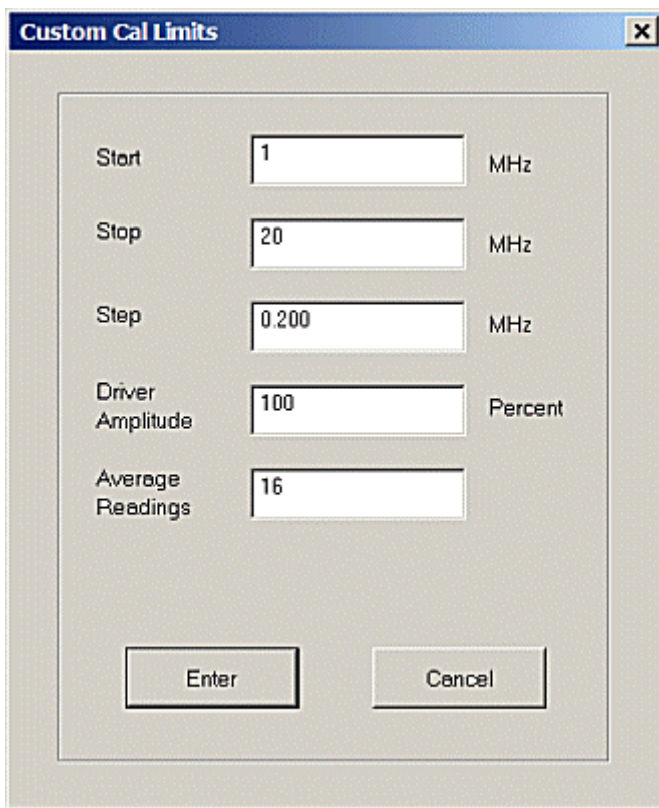

Parameter	Value	Unit
Start	1	MHz
Stop	20	MHz
Step	0.200	MHz
Driver Amplitude	100	Percent
Average Readings	16	

The user specifies the **start**, **stop** and **step frequency** values for the calibration. Typically the step frequency will be much less than 1MHz to take advantage of the improved accuracy when a complex circuit is connected between the RF connector and the measurement point. The cal data points should be close enough together that the response characteristics of the interconnecting cables and/or filters does not change much between data points. Up to 20,000 points can be used for a Custom Calibration. When the custom cal procedure is completed, the program will check the data to see if the data points are close enough together. Sometimes it may display an alert that the data seems

to be too coarse, in that case you can accept the data and continue or redo the calibration with a smaller freq step size.

There is an option to program the **output level** of the driver to some percentage less than full scale (which is approximately +7dBm) . This can be useful when testing circuits that are sensitive to the input signal level, like crystal filters and amplifiers.

The **open, short** and **resistor** loads are used. The resistor value is not critical as long as it is accurately known. The same resistor that is used for the **standard cal procedure** can be used if an appropriate connector is available. When adapters are used, be sure to be consistent so that all three loads have the same capacitance and inductance. For the open cal load, be sure to use an actual open connector. If the open cal load is not attached to the test connector, the stray capacity will not be properly calibrated. For a BNC connector, this represents an error of approximately 3 to 4 pf.

Click **Calibrate -> Custom Cal** and the parameter entry dialog box will open.

By default, data entries are in MHz but if a number is followed by a **K** or **k** then the number will be interpreted as KHz.

After the start, stop and step limits are entered, there will be prompts to attach the short, open and resistor loads. Note that this routine **does not** check the value of the load (like the standard cal routine does), so be careful to attach the appropriate one. After the calibration is complete, there is a prompt for an optional comment to be included with the cal data file. Then the name of the data file is entered. The name can be anything, but you may want to make the custom cal files distinctive from the standard cal files so it's easy to tell them apart. The file extension will automatically be set to **.acal**. After calibration, a scan is done automatically (without plotting the data) to see if the custom cal data is likely to be accurate enough for this particular setup. When the external circuit has rapid changes in phase (such as a filter), the custom delta freq has to be small enough to include data during the phase transitions. In some cases it may be necessary to use a delta as small as 1KHz.

If a warning message is displayed, the cal data may still be ok in the frequency range of interest. The overall results should be evaluated with known loads, such as resistors with good RF characteristics.

When a custom cal file is being used, the words "**Custom Cal**" will appear in red above the graph. The scan **start/stop and delta limits can be changed** without having to do the custom cal again.

After the calibration of Port A is completed, there is an option to calibrate Port B. If Port B is going to be used with the specified **driver amplitude**, calibrate it now by attaching the **through-cable** between ports A and B.

The comment that is included in the current cal file can be viewed by clicking the **Status** button. The status window also shows the start, stop and delta parameters used for this

custom cal file. *If a custom cal file is not being used, these data do not appear in the status window.*

The effectiveness of the custom cal procedure can be seen in the following examples. For this series of tests, a transmission line made up of two different kinds of coax was used:

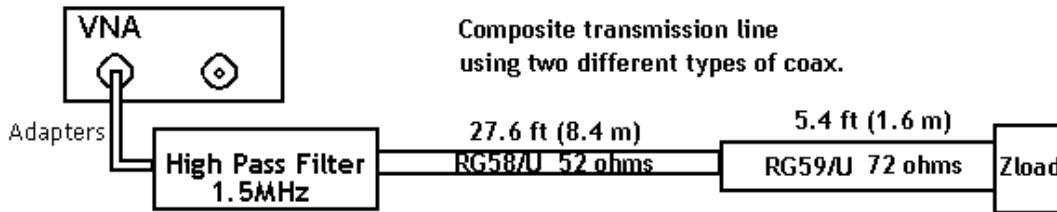

The high pass filter cuts off below 1.8MHz. It's a **Broadcast Band High Pass Filter** from **Array Solutions**. (see their website for more information). This is very useful for rejecting local broadcast stations while tuning a 160 meter antenna. Inserting this filter will normally preserve the SWR readings around 160 meters but the impedance and phase angle may be changed. By calibrating at the far end of the filter, the VNA can then transform the antenna data and significantly reduce the distortion caused by the filter.

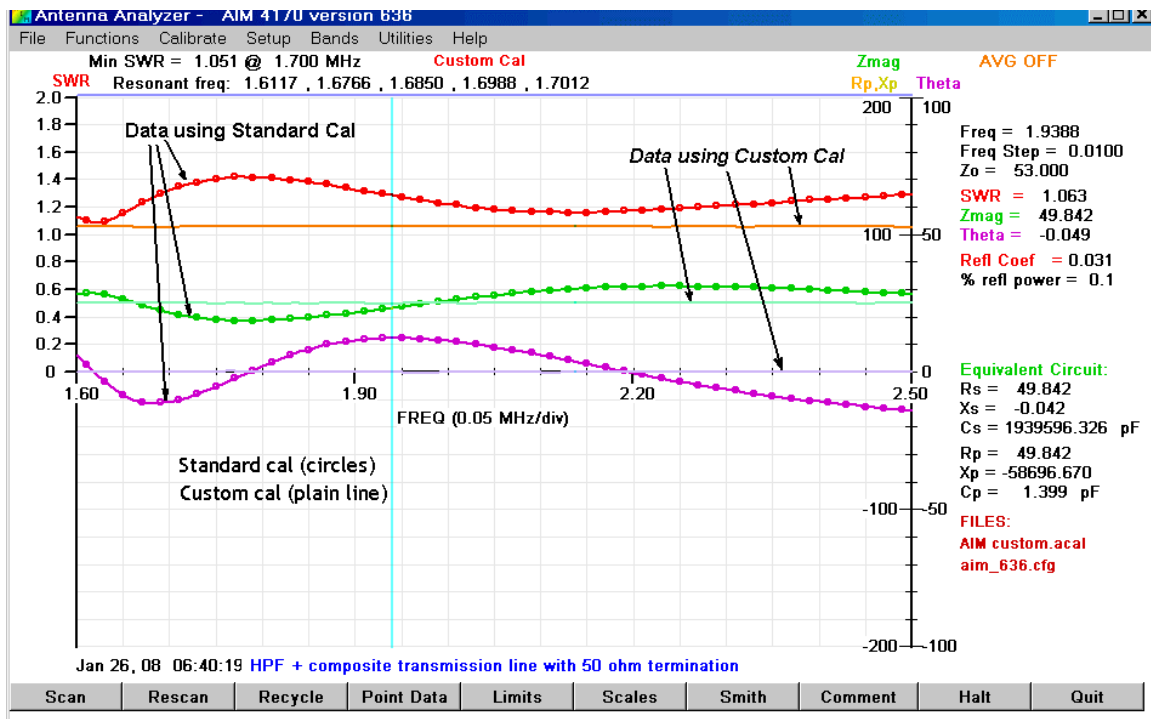

(AIM4170 screen, equivalent to VNA2180)

The figure above shows a scan using the **standard** calibration method when the composite transmission line above is terminated with 50 ohms. This scan is **highlighted with dots** along each of the three traces: SWR, Zmag, and Phase. The SWR shows some variation. The phase angle is off about 15 degrees at 1.95MHz.

Then a scan was done using **custom** calibration data obtained at the end of the transmission line. The new data is plotted with plain lines. Now the data is flat, indicating a nearly ideal 50 ohm termination. The phase angle is essentially zero; *it lies on the x-axis so it's not easy to see*.

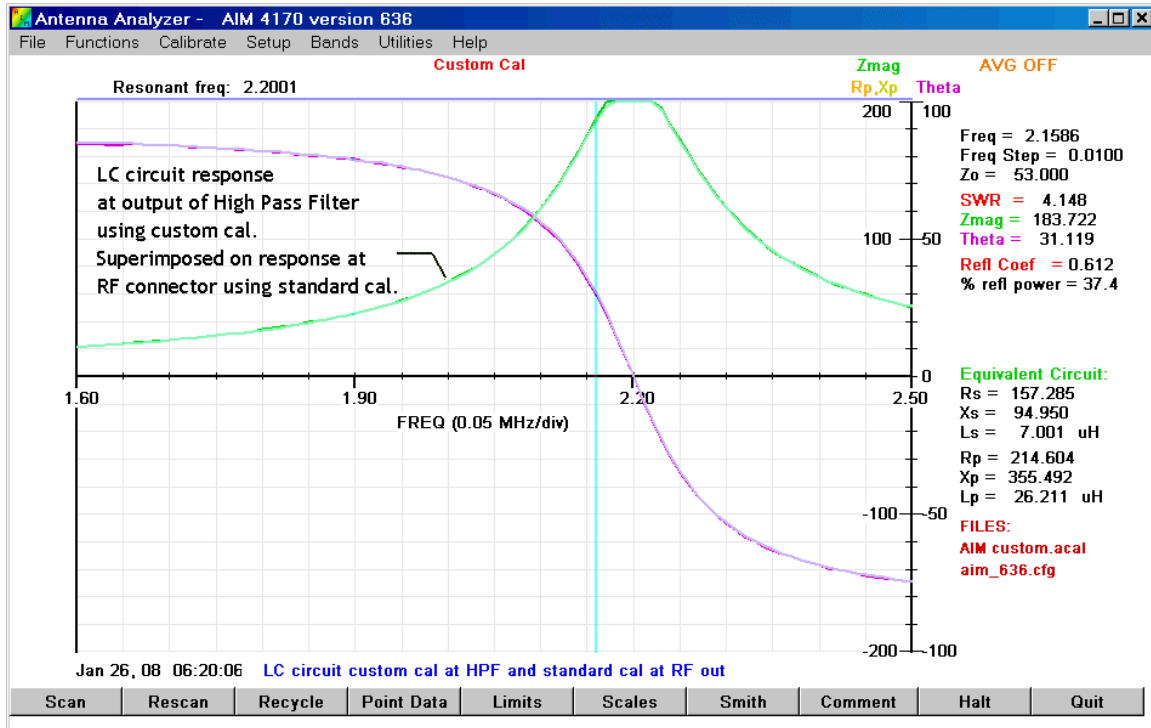

(AIM4170 screen, equivalent to VNA2180)

The figure above shows the results when using an LC parallel tuned circuit for a load. One scan was taken with the LC circuit connected **directly** to the RF connector using **standard cal** data.

Then the LC circuit was moved to the end of the composite transmission line (shown previously) and another scan was done with the **custom cal** data. When the two scans are overlaid, they are very close to each other. This before and after comparison was done by loading a new cal data file without changing the scan limits. Then click **Rescan** and the new scan overlays the original data. The same type of comparison can also be done by loading a stored graph file and clicking rescan.

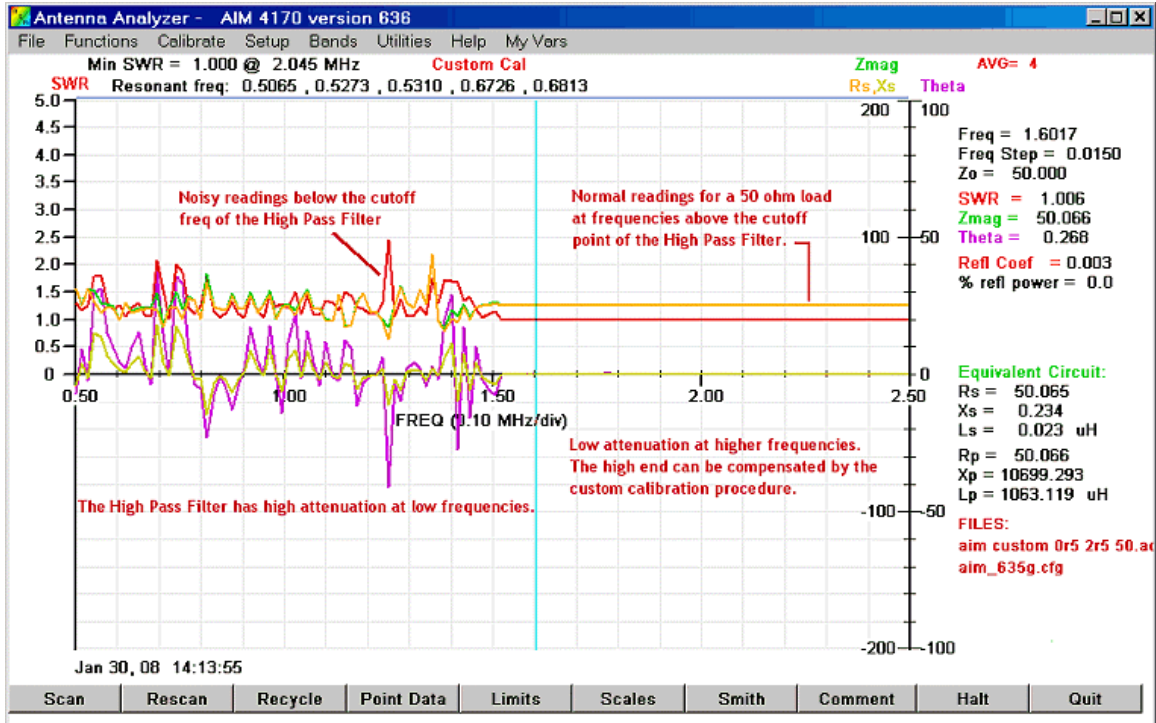

(AIM4170 screen, equivalent to VNA2180)

This scan shows the effect of a High Pass Filter that has high attenuation in the AM radio broadcast band. It is very effective in reducing interference picked up on a 160 meter antenna. The filter's cutoff frequency is about 1.6 MHz. To cancel the effect of the filter in the 160 meter band (1.8 to 2.0 MHz), the **custom calibration** procedure can be used.

Below 1.6MHz, the cal data is noisy due to the attenuation through the filter. This is because the instrument sees essentially the same thing when any of the calibration loads are attached, so the compensation data is not consistent with the specific load. Above 1.6MHz the signal through the high pass filter is normal, with low attenuation, and the calibration is accurate. The 50 ohm load can be read accurately in the frequency range of interest, 1.8 to 2 MHz.

When using new filters or baluns that may have limited bandwidths, be sure to evaluate the results using loads with known characteristics before measuring the antenna itself.

Data Referred to Antenna

Sometimes it is desirable to know the impedance right at the antenna terminals. The most accurate method uses the **Custom Calibration** procedure discussed previously. In some cases it may be impractical to disconnect the coax from the antenna feed point, so another procedure is available that only requires data from the manufacturer's spec sheet.

This method of transforming the data to the antenna can be used when the properties of the transmission line (Z_0 , length, loss and velocity factor) are accurately known. This does not require disconnecting the transmission line from the antenna. It should only be used for transmission lines that employ a single type of coax.

To select this feature, click **Functions** -> **Refer to Antenna**.

Then enter the transmission line data in the dialog box.

The length and velocity factor are combined to find the effective **electrical length**. Rather than trying to measure the physical length of the transmission line and estimate its velocity factor (which may vary from one roll of coax to another), you can measure the **electrical length** directly using the VNA2180. Put a **short circuit** across the antenna terminals (or disconnect the coax from the antenna) and scan to find the first point where the phase angle is zero. This is listed at the top of the graph as the first **resonant freq**, F1. This frequency corresponds to one-quarter of a wavelength, so the **electrical length** of the line is:

$$\begin{aligned} \text{Electrical_length} &= 0.25 \cdot (299.8/F1) \text{ meters} \\ &= 0.25 \cdot (984/F1) \text{ feet} \end{aligned}$$

This corresponds to the physical length of the coax divided by its velocity factor. The electrical length is longer than the physical length since the velocity factor is less than one. Radio waves only care about the electrical length. When entering the cable parameters, if you know the electrical length (by measuring F1 above), the top line can be a close “estimate” of the physical length and the velocity factor is the electrical length that was accurately measured, divided by this “estimate”. For example, when I installed the antenna did I use 120 feet or 125 feet of coax? Rather than trying to measure the length of the coax again, estimate its length as 125 feet. Assuming the electrical length was measured to be 185 feet, the velocity factor would be $125/185 = 0.6757$.

Alternatively, if you know the velocity factor, calculate the physical length by multiplying the velocity factor times the electrical length.

The cable loss is usually given in terms of “dB per 100 feet” on data sheets. Enter the value of loss for 1MHz, if it’s listed. If you’re interested in higher frequency bands and want a bit more accuracy, pick a frequency close to your region of interest and divide the loss at this frequency by the **square root** of the frequency in MHz.

For example, if the loss at 10MHz is 1.5dB/100feet, enter $1.5/\text{SquareRoot}(10) = 0.47$ dB/100 feet for the loss. This attenuation value is close to the value at 1MHz. You can enter loss as either a positive or a negative number, it doesn’t matter.

When calculating loss, the **physical length** of the cable is used. Although the physical length of the coax may not be known with great accuracy, the loss has a secondary effect and it’s not as critical as the electrical length. Using 120 feet or 125 feet for the loss calculation will not affect the final answer very much, but the **ratio** of physical length to the velocity factor is important (as mentioned above).

The nominal impedance, **Z_o**, of the coax is very important. This can be found from the manufacturer’s data sheet. It does vary from one manufacturing run to another and it varies somewhat along the roll of coax. This value may be fine tuned by using a known terminating resistance of a few hundred ohms to experimentally optimize the transformed value. After the cable is characterized by testing the actual cable or an equivalent piece of cable (ideally, from the same roll), the transformed impedance values will be accurate to within a few percent.

Line Extension

When an adapter is used to connect a line to the VNA2180, there will be some shift in the displayed parameters due to the phase shift in the adapter. This can be compensated by doing the regular calibration with the adapter in place. Alternatively, it can be compensated by treating the adapter as an extension of the transmission line and reversing the phase shift. The extension is assumed to be a short piece of **ideal coax** (no loss) with a specified length, characteristic impedance (Z_0) and velocity factor. There is no limit to the length, but typically the length of the extension will be relatively short. The default unit of length is **centimeters**. The length can be entered in inches, feet, or meters by following the number with an "i", "f" or "m" (upper or lower case can be used). The line extension only applies to data scanned at Port A.

The length can be **positive or negative**. Enter **zero** or click "**Disable**" to turn the extension function **off**.

Click the **Line Extension** button on the right side of the screen to set the parameters.

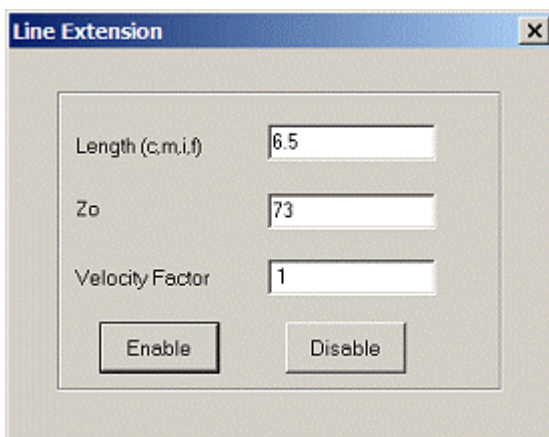

The screenshot shows a dialog box titled "Line Extension" with a close button (X) in the top right corner. The dialog contains three input fields with labels to their left: "Length (c,m,i,f)" with the value "6.5", "Zo" with the value "73", and "Velocity Factor" with the value "1". Below these input fields are two buttons: "Enable" and "Disable".

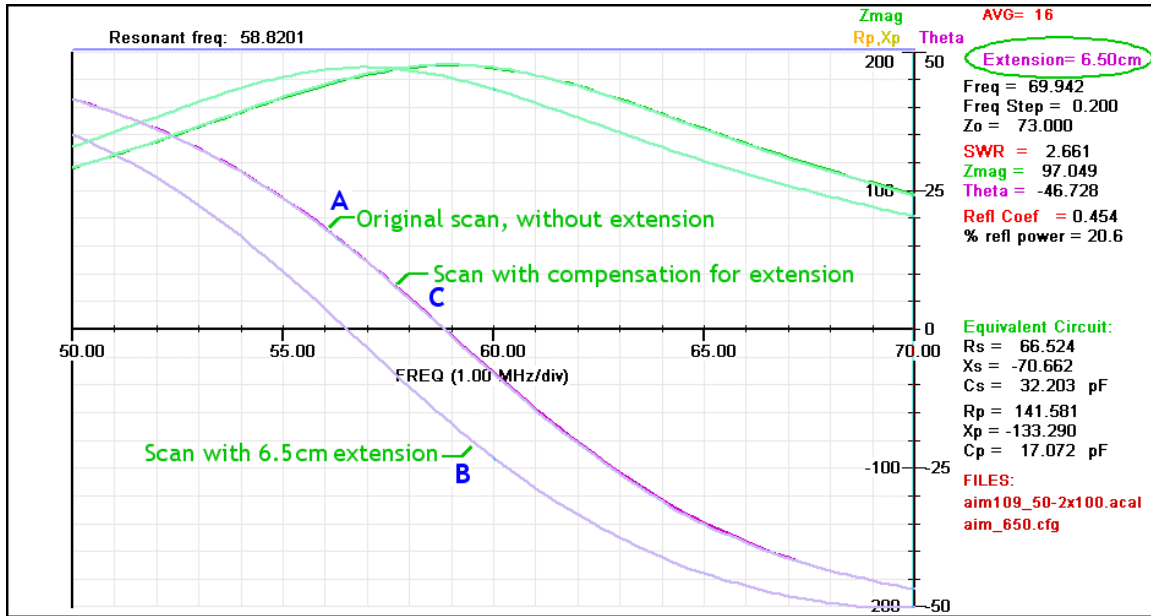

This graph shows the effect of inserting an adapter in series with a piece of RG59/U coax that is terminated with a 200 ohm resistor.

- A-** The first trace for the phase crosses the frequency axis at 58.8 MHz.
- B-** When the adapter, which is 6.5 cm long (electrically) is inserted, the phase plot crosses at 56.5 MHz since the line appears to be longer now and the frequency corresponding to a half wavelength is lower.
- C-** Enabling the line extension function with length=6.5 cm, $Z_o=50$, and Velocity Factor=1 compensates for the extension and the last trace coincides with the first trace that was made without the extension.

Note the value for **Z_o** corresponds to the adapter that is being compensated, not to the transmission line. Depending on the construction of the adapter, it may take some experimentation to find the equivalent length. Only the **electrical length**, not the physical length, is important for this function, so the velocity factor can be left at 1.0 if desired.

Markers

Markers can be defined to aid in collecting data at specific frequencies. Position the cursor near the desired point and **right click**. The marker frequency at the cursor appears in a dialog box. This value can be changed with a keyboard input. The marker index number is assigned automatically. The markers are always sorted by increasing frequency. A number followed by **k** or **K** is considered to be in kilohertz, otherwise, it is in megahertz.

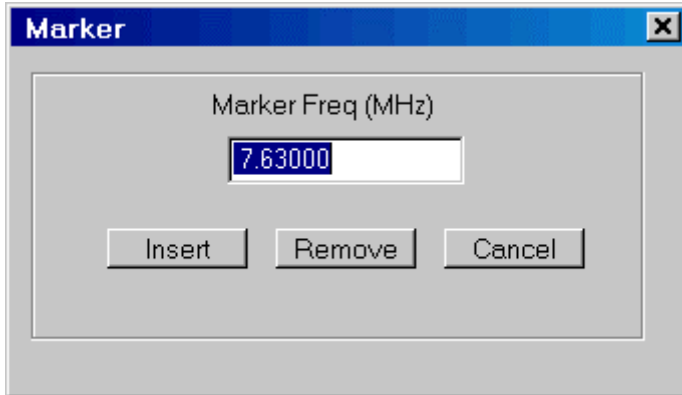

Click the **Insert** button to add a new marker or the **Remove** button to remove a marker. When removing a marker, the one closest to the cursor position will be removed. The cursor does not have to be positioned exactly on the marker.

As markers are entered, they are displayed as red dotted lines, as shown below. The marker display can be turned on or off with the *marker toggle* function (see below). After a marker is inserted or removed, the set of markers will be resorted in the order of ascending frequency. Up to 20 markers can be entered at one time. Sets of markers can be saved in files and recalled later.

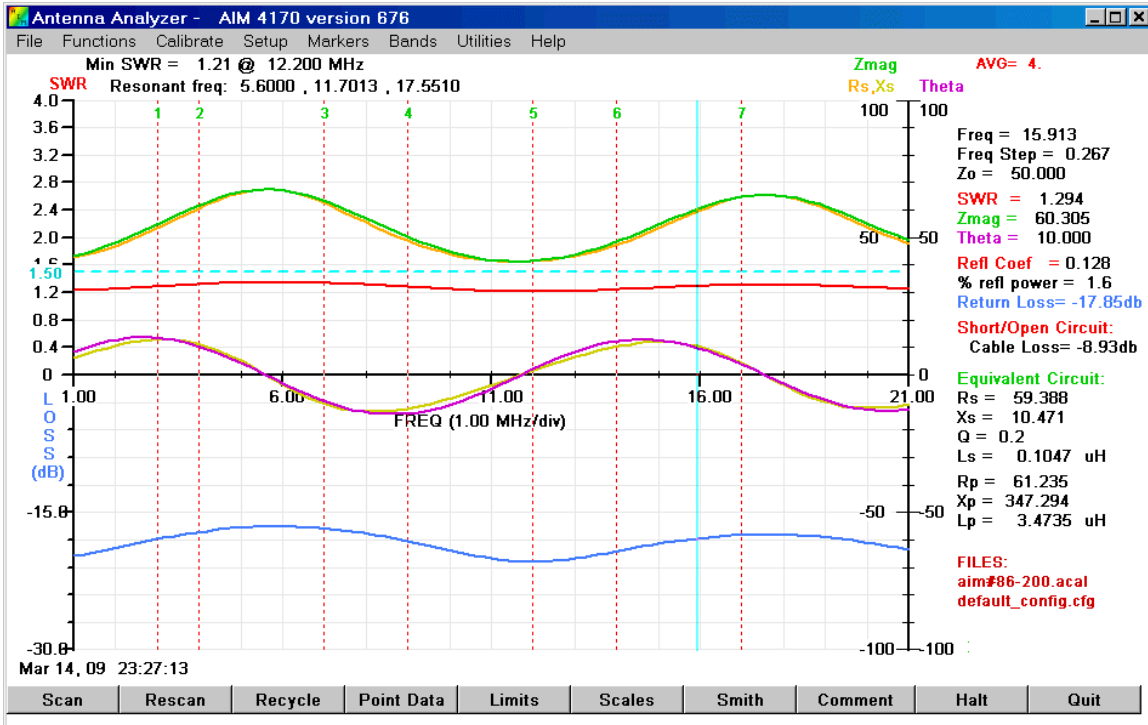

(AIM4170 screen, equivalent to VNA2180 Port A)

Markers are controlled using the menu items under the **Marker** tab:

Several options for the markers are shown in the submenu below:

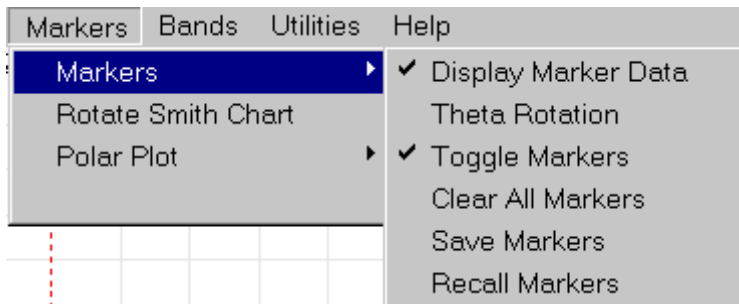

Display Marker Data – open a window to display all the presently defined markers and the data at these frequencies. The data is read once when the window is opened. Click **Refresh** to take another set of readings. Click **Recycle** to read the raw data at the marker frequencies repetitively. In the Recycle mode, the horizontal gauge in red shows the SWR graphically on a log scale from 1 to 5. This corresponds to the actual numeric value of SWR displayed in the third column. This feature is very useful when adjusting multiband antennas since the SWR in each band is displayed in real time while adjustments are made. Several markers can be defined for each band to get an idea of the bandwidth. The following image shows marker data for a two-band trap dipole with five markers per band:

Marker Data							
Mar 18, 09 19:51:43		Refresh Recycle Save Recall Print Exit					
Reference Z = 50 + j 0		Two-band trap dipole					
Marker	Freq	SWR		Rs	Xs	Zmag	Theta
[1]	13.075000	4.1020		177.916	45.850	190.156	-20.669
[2]	13.860000	2.4415		105.904	29.730	112.236	-19.337
[3]	14.340000	1.6351		81.632	17.276	81.670	1.760
[4]	14.755000	3.0325		120.223	36.465	133.084	25.396
[5]	15.035000	4.7237		220.608	50.234	227.903	14.536
[6]	20.530000	2.9874		17.005	36.000	18.018	19.307
[7]	20.880000	2.2892		24.130	27.730	28.088	30.788
[8]	21.360000	1.0418		52.073	3.274	52.074	0.307
[9]	21.880000	2.7265		21.052	33.160	27.495	-40.034
[10]	22.190000	3.8701		13.394	44.042	16.277	-34.626

The numbers in parentheses in the first column are the marker index numbers. The markers frequencies do not have to be equally spaced.

If the graph presently displayed is from a scan that has been saved, the marker data will be taken from that data in memory and no new data is read from the hardware. In this case, if some of the markers are outside the scan limits, a reminder will pop up indicating that data for some of the markers cannot be read. Also, the **refresh and recycle buttons** will be grayed out.

Phase Rotation – The marker data can be transformed to correspond to data that would be measured at the end of a transmission line with a specified electrical length or a network with a specified phase shift.

Toggle Markers - turn the marker display on/off without changing the markers in memory.

Clear all Markers – removes all markers from memory.

Save Markers – saves this set of markers to a user specified file. Any number of marker files can be saved. These files have the extension ***.mrk**.

When the marker data is saved using the **SAVE** button on the marker data window, a second file is also saved in a comma-separated-variables format (csv). This file has the same user specified name and the extension ***.mrx**. It can be input to a spreadsheet, such as, **Excel**.

When the VNA program is closed, the present set of markers is saved in the *.ini file.

Recall Markers - recall a set of markers from a file.

Rotate Smith Chart – A second Smith chart can be displayed. There is an option to rotate its data by an angle corresponding to electrical distance along a transmission line or phase shift in a network. The actual geometric rotation of the plot on the chart will be twice the value of the angle that is entered.

Polar Plot – In addition to the Smith chart, several parameters can be plotted in **polar format**. The parameters are: SWR, Z and s_{11} .

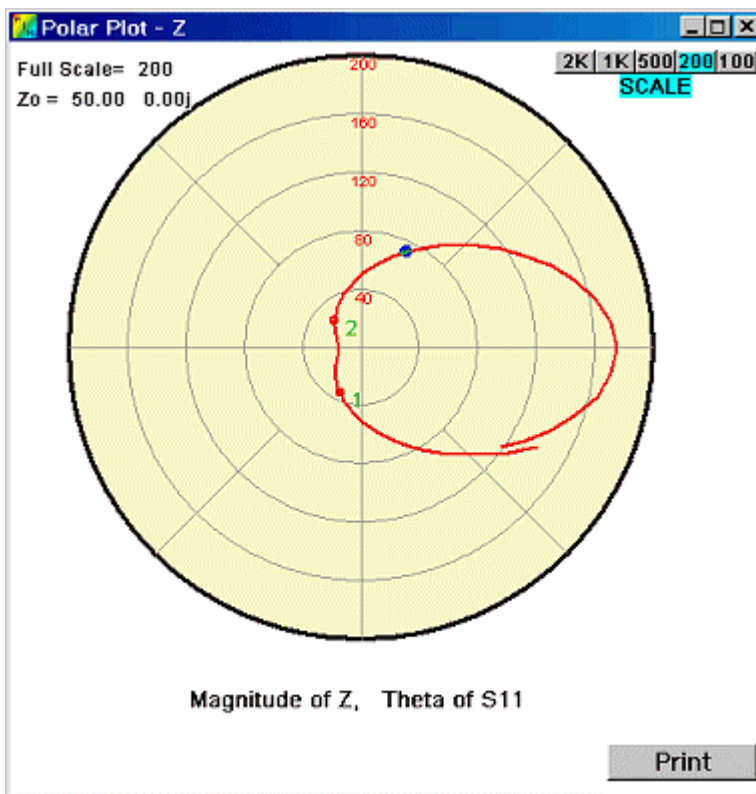

Smith Charts

Click on the button labeled “Smith” at the bottom of the graph to open a window with a Smith chart showing a plot of the reflection coefficient versus frequency. As the cursor is moved with the mouse over the **original** scan, a marker dot is displayed at the corresponding point on the Smith chart and the relevant data is displayed on the right side of the graph.

Note, the point that is highlighted on the Smith chart corresponds to the frequency on the horizontal frequency axis of the original graph. This graph may be under the Smith chart and the horizontal axis, hence, it may not be completely visible. The Smith chart window can be moved to optimize the display.

A green circle of constant SWR will be displayed when the **SWR Ruler** (see the **Setup** menu) is set to a value greater than 1.0. The SWR reference value is shown in the upper left corner of the Smith chart window.

A red dot marks the start of the Smith chart trace.

The center of the Smith chart corresponds to 50 ohms in the example below. The Z_0 value is specified using the Setup Menu. Z_0 can be any value and can be a complex number.

Buttons in the upper right corner of the Smith chart window provide for zooming by factors from 1x to 5x. When the second Smith chart is displayed, it can have a different zoom value. (see Marker Menu)

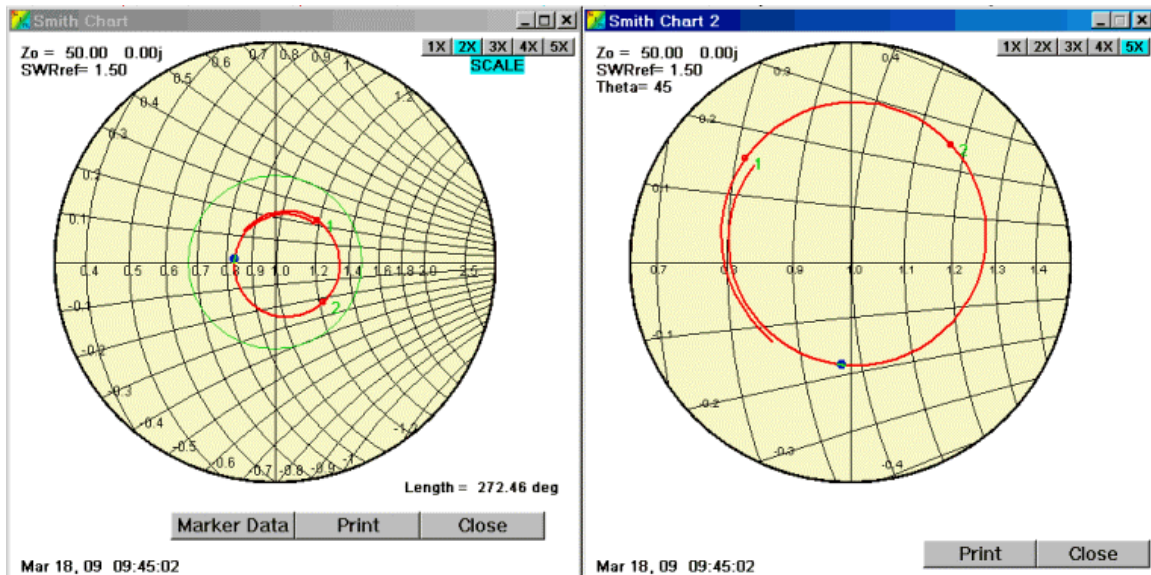

Smith charts of the same scan with zoom values of 2x and 5x. The right hand Smith chart has an offset of 45 electrical degrees. (geometrical plot rotation is 90 degrees)

VNA2180 Principles of Operation

The VNA2180 is based on the same technology used in the AIM430 and AIM4170.

1. An RF voltage is applied to the transmission line input.
To reduce the chance for interference to nearby radio receivers, the maximum output power is less than 10 milliwatts (10 dBm).
2. Measure the applied voltage and the current flowing into the load. The current is measured across a precision resistor which has a much wider bandwidth than a transformer. (The VNA2180 does not use any RF transformers). The current sensing resistor does not have to be adjusted and it has excellent long-term stability.

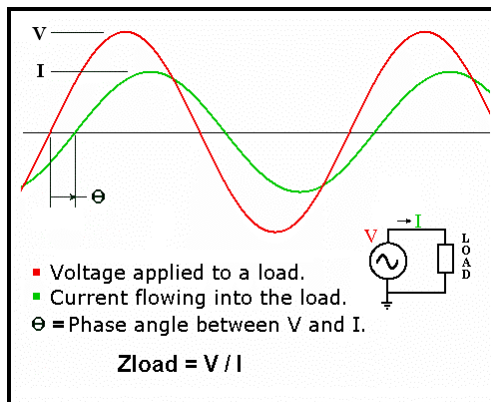

3. Calculate the magnitude and phase of the input impedance. The magnitudes and phases of the applied voltage and resultant current are measured with an analog to digital converter (12-bit ADC) and their ratio determines the magnitude of the impedance. The sign of the phase is also measured so that capacitive and inductive reactances can be distinguished.
4. The signal processing circuits are linear, so the nonlinearity problem inherent with diode detectors is eliminated.
5. Calculate various parameters including: SWR, equivalent input resistance and reactance, cable length, cable loss. A large number of parameters can be calculated using the fundamental impedance measurement. The load is assumed to be an antenna but the data is displayed in such a way that discrete capacitors and inductors can be measured too. These values are plotted versus frequency and the exact numeric data can be read by moving a cursor to the point of interest.

Block diagram of the VNA2180:

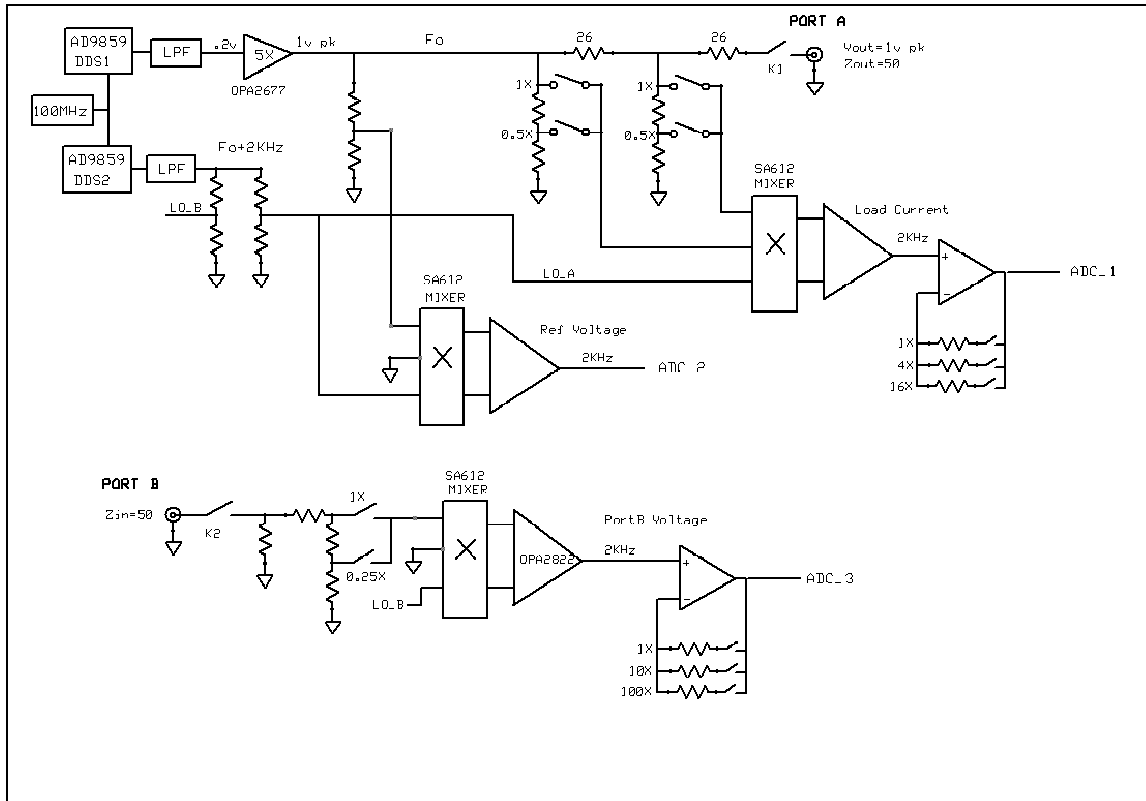

The VNA2180 uses two Direct Digital Synthesizer (DDS) chips. One generates the test signal and the other acts as a local oscillator to heterodyne the RF signals to the audio range. You can read about the basic principles of the DDS at this address: <http://www.analog.com/library/analogDialogue/archives/38-08/dds.pdf>

A 100 MHz crystal controlled oscillator drives both of the DDS chips. Inside the DDS, the clock is multiplied by a factor of 4, so the effective clock rate is 400 MHz. Program frequency resolution is a fraction of a Hertz. The output of each DDS goes to a 180 MHz low pass filter to remove the harmonics of the digitally generated signal. The output of the low pass filter is a sine wave in the range of 0.1 MHz to 180 MHz. Any amplitude variations or phase shift in the low pass filters do not affect the measurement accuracy since they affect the current and the voltage channels equally and thus cancel out when the ratio is taken.

The output of one DDS supplies the test voltage and current to the load impedance and the other DDS acts as the local oscillator to heterodyne the voltage and current signals down to 1kHz. Audio amplifiers boost the 1kHz signals and drive the input to the 12-bit analog to digital converter (ADC) that is inside the MSP430 microprocessor. This microprocessor is mounted inside the VNA2180 case. The raw data is sent from the

microprocessor to the external PC via the USB port. The PC calculates the various data values and displays them graphically.

Reflection Coefficient:

To find the SWR (standing wave ratio) of an antenna, we first calculate the **reflection coefficient**. This is the ratio of the voltage that is reflected at the antenna to the voltage that arrives at the antenna from the transmitter. If all the power from the transmitter is radiated into space, there is no reflection, the reflection coefficient is zero and the SWR=1.0.

*The following discussion uses the concept of complex numbers. A tutorial on complex numbers is available in **Appendix 2**.*

$$\text{Reflection_Coefficient} = \text{Rho} = (Z_{\text{load}} - Z_0) / (Z_{\text{load}} + Z_0)$$

Z_{load} = antenna impedance

Z_0 = transmission line impedance

Note that in general, Z_{load} and Z_0 are complex numbers of the form:

$$Z_{\text{load}} = R_a + jX_a \quad \text{and}$$

$$Z_0 = R_o + jX_o.$$

X_o , which is the imaginary part of Z_0 , is often neglected since it is usually small compared to the real part, R_o .

Since **Z_{load}** is a **complex number**, the reflection coefficient, **Rho**, is also a **complex number**.

The reflection of the incoming power from the transmitter is caused by a mismatch between the **transmission line impedance** (Z_0) and the **impedance of the antenna** at the operating frequency. For example, if the transmission line has an impedance of 50 ohms and the antenna is a dipole with an impedance of around 75 ohms, there is a mismatch and some of the power is reflected even though the antenna itself may be very good. If the transmission line is changed to 75 ohms, the match is much better, there is less reflection and the SWR is closer to 1.0.

In the special case where the transmission line is open at the antenna (perhaps due to a broken wire), all of the power that arrives at this open circuit will be reflected back toward the transmitter and the reflection coefficient is +1.0 and the SWR= infinity. Another interesting case is when the transmission line is shorted at the antenna terminals. Again, all the power will be reflected (none is radiated) but the signal is inverted, so the reflection coefficient is now -1.0 (minus one). The magnitude is still unity (that is, +1) and the SWR=infinity.

Thus, we see that the *magnitude* of the reflection coefficient will be in the range of zero to 1.0 for any combination of transmission line and antenna.

The reflection coefficient also has an associated *phase angle* between the incident voltage from the transmitter and the reflected voltage. The real and imaginary parts of Rho can be related to its magnitude and phase angle with the following equations:

$$\text{Real_part_of_Rho} = \rho_a = \text{Magnitude_of_rho} * \text{COS}(\text{PhaseAngle})$$

$$\text{Imaginary_part_of_Rho} = \rho_b = \text{Magnitude_of_rho} * \text{SIN}(\text{PhaseAngle})$$

$$\text{Rho} = \rho_a + j \rho_b$$

Standing Wave Ratio (SWR):

SWR is the ratio of the Maximum Voltage to the Minimum Voltage along a transmission line. On a perfectly matched line, the maximum is equal to the minimum since there is no variation in the voltage along the line and the SWR is 1.0. In the real world, SWR is somewhere between 1.0 and infinity. The special case of infinity means all the power from the transmitter is reflected back by the antenna. This would be the case for a short circuit or an open circuit at the antenna when using a lossless transmission line.

If the transmission line has no loss, the SWR is the same at all points along the line. That is, the SWR at the transmitter is the same as it is at the antenna. As the transmission line loss increases, the effect is to make the SWR measured at the transmitter appear to go *down* since less power is received back from the antenna. This power gets lost along the transmission line, so it does not arrive at the SWR meter and the meter responds more to the outgoing power from the transmitter. The meter thinks the antenna is a better match than it really is because there seems to be less reflected power.

The SWR only depends on the *magnitude* of the reflection coefficient, Rho:

$$\text{SWR} = [1 + \text{magnitude}(\text{Rho})] / [1 - \text{magnitude}(\text{Rho})]$$

This shows that when the magnitude of Rho = 0 (that is, the transmission line and the antenna are a perfect match), the SWR is $[1+0]/[1-0] = 1$ (this is the ideal case).

When the mismatch is very large and the magnitude of Rho is nearly 1, the term in the denominator approaches zero and the SWR approaches infinity.

Since only the magnitude of Rho appears in this equation, SWR is **not** a complex number (it's called a real number).

Measurement of Crystal Parameters

Quartz crystals can be modeled as shown below:

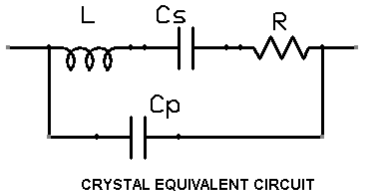

The series resonant frequency is the lower of the two frequencies. It's determined by L and Cs. The higher parallel resonant frequency is determined by L and Cp+Cs.

A broad scan can be done to locate the resonant frequencies. They will be displayed at the top of the screen. Typically, these two frequencies only differ by a few kilohertz.

(The screen pictures in this section were taken using an AIM430. The same features are included in the VNA2180.)

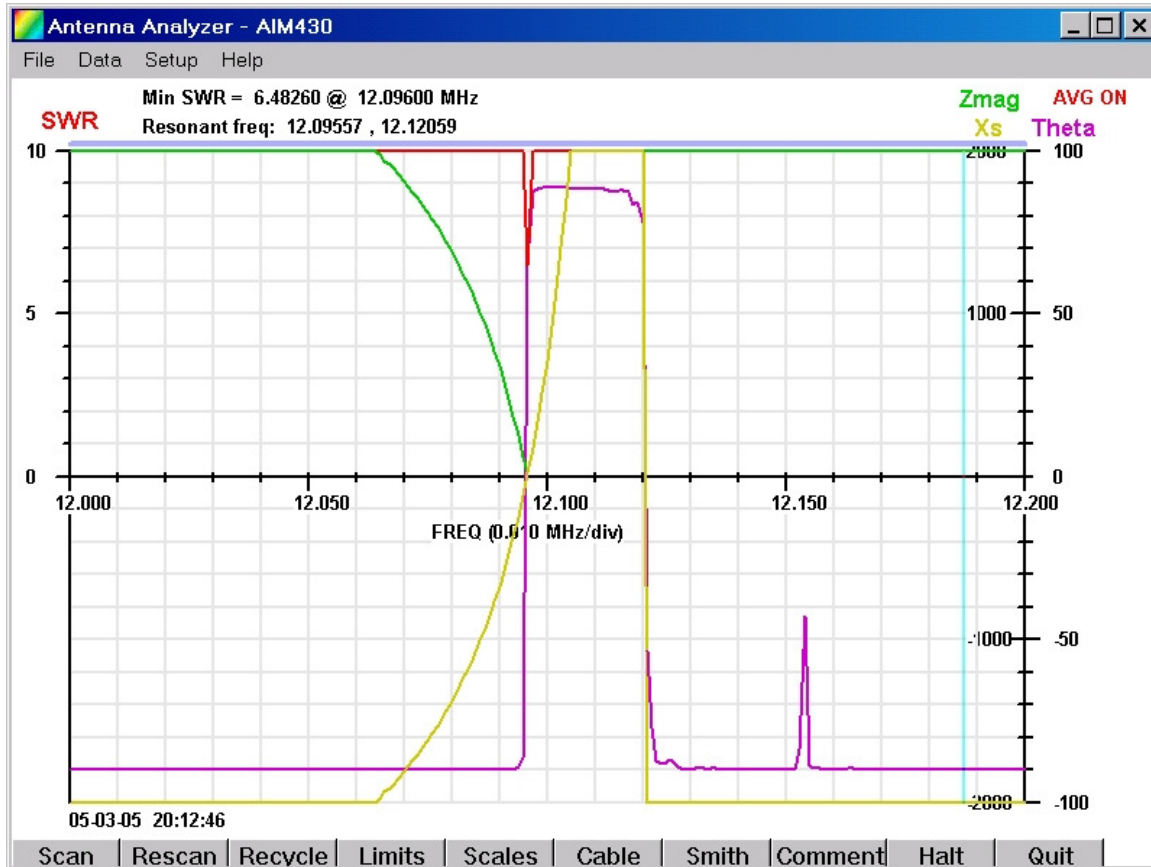

(AIM430 screen, equivalent to VNA2180 Port A)

Automatic Crystal Parameter Calculation

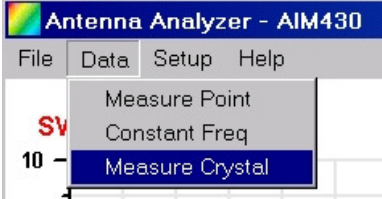
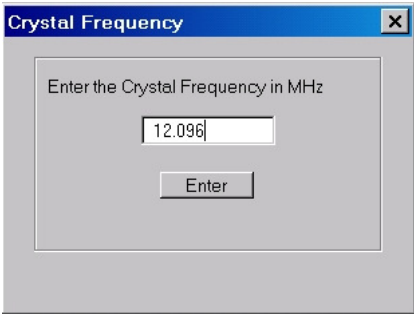
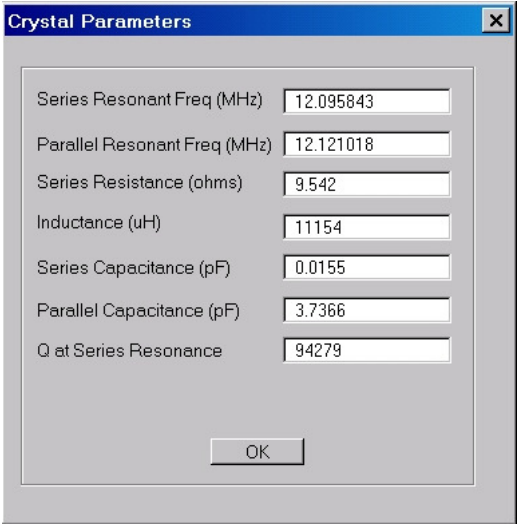
<p>The calculations to find the crystal parameters are tedious so they have been combined into a procedure than can be called from the Data menu. First click “Measure Crystal”:</p>	
<p>Then enter the series resonant frequency.</p> <p style="color: red;">This should be within 100KHz of the series resonant frequency. When measuring an overtone crystal, enter the appropriate harmonic frequency.</p>	
<p>After a few seconds the crystal parameters will be displayed. A parameter to specify the number of readings to average for the parallel resonant frequency is in the config file. The default value is 32.</p> <p>The data can be saved in a file. If the file already exists, the data will be appended (added) to it. If the file does not exist, a new one will be created with the .xdat extension.</p> <p>This file is compatible with programs that read comma separated variables (*.csv) files, like Excel. A legend is included at the beginning of the file to show the variable name in each column. An Excel utility can be used to sort the data to determine the best crystals to use for a particular filter.</p>	

The following discussion goes into more detail about the crystal calculations.

After the resonant frequencies are located, you can change the scan limits to focus in more detail on the region of interest.

At the series resonant frequency, the reactances of L and Cs cancel out and the magnitude of the impedance becomes equal to R. Therefore, the series resistance of the crystal can be read directly at the minimum value of Zmag on the graph; the numeric value is Rs in the Data Window.

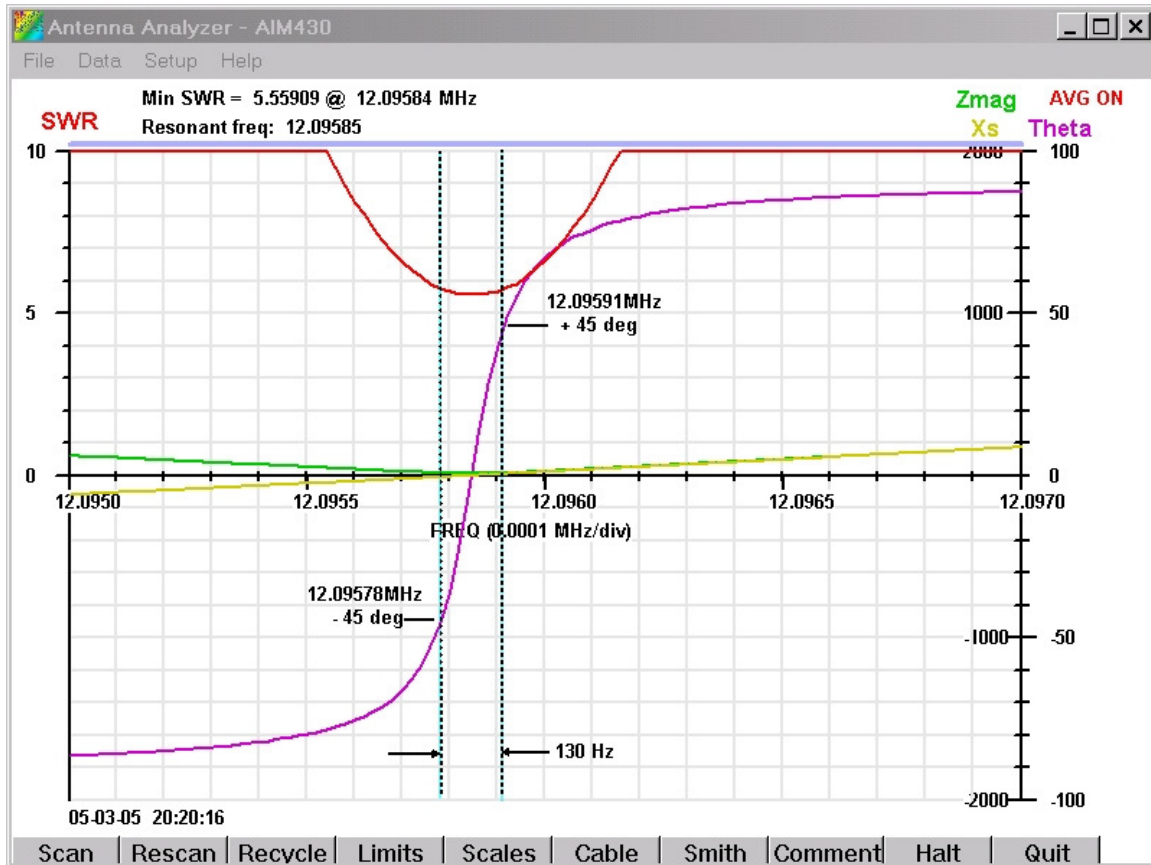

(AIM430 screen, equivalent to VNA2180 Port A)

At frequencies well below the series resonant point, the impedance value is the total capacitance, Ctotal, which is essentially equal to Cparallel. Cparallel is read at a frequency equal to 78% of the series resonant frequency.

$$C_{total} \text{ approx} = 4.5 \text{ pF}$$

The value of Cseries is given by:

$$C_{series} = C_{total} * 2 * (\text{Freq}_{parallel} - \text{Freq}_{series}) / \text{Freq}_{parallel}$$

Where Freq_parallel is the **parallel** resonant frequency and Freq_series is the **series** resonant frequency.

$$C_{\text{series}} = 4.5\text{pF} * 2 * (12.12059 - 12.09557) / 12.12059 = \underline{0.0186\text{pF}}$$

The inductance L is given by:

$$L = 1 / (4 * \pi * \pi * \text{Freq_series} * \text{Freq_series} * C_s)$$

$$L = 1 / (4 * \pi * \pi * 12.09557\text{MHz}^2 * 0.0185\text{pf}) = \underline{9308 \text{ uH}}$$

The **Q of the crystal** is found by measuring the two frequencies F1 and F2 on either side of the Freq_series where the **phase angle** is +/- 45 degrees.

$$Q = \text{Freq_series} / (F2 - F1)$$

$$Q = 12.09585 / (12.09591 - 12.09578) = \underline{93045}$$

Frequency Source

When the VNA2180 is used as a signal source, DO NOT connect it directly to the antenna connector of a transceiver. If the transmitter is accidentally turned on, the output will exceed the maximum safe input level to the VNA2180.

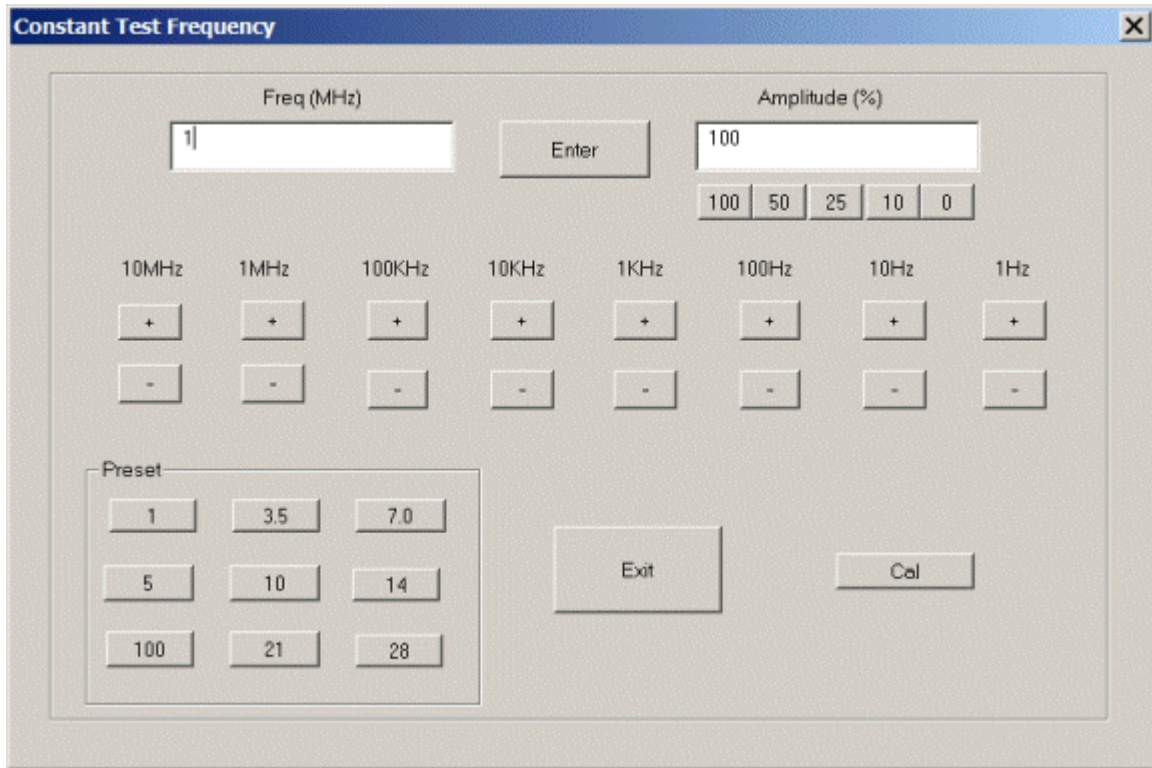

The VNA2180 can be used as a signal source for testing electronic circuits, such as radio receivers. The programmed frequency has a nominal accuracy of ± 30 ppm and it can be calibrated with respect to WWV at 10MHz. The output impedance of the VNA is 50 ohms up to 60MHz and rises to about 100 ohms at 150MHz. The nominal signal delivered to a 50-ohm load is about 700mV rms at 1 MHz and somewhat less at high frequencies. The amplitude of the output is can be programmed as a percentage of full scale.

Enter a frequency value in the text window and click “Enter”. The frequency can then be incremented or decremented by clicking the +/- buttons.

To calibrate the frequency to WWV, tune in WWV at 10MHz and adjust the VNA2180 output to zero beat with it. Then click the “cal” button shown in the dialog box above. This will apply a correction to all frequencies that are programmed later (including regular scans for measuring impedance and transmission characteristics.) The correction is also saved in the .ini file and automatically recalled each time the program starts up.

Port B Functions

Port B has a nominal input impedance of 50 ohms with a return loss greater than 30dB (SWR < 1.07). Port B provides a termination when Z_{in} of a two port filter is being measured. The input to Port B is DC coupled and the maximum voltage should not exceed 5V rms. The maximum input voltage for a measurement is 1V peak (10dBm). This should be taken into account when measuring the frequency response of an amplifier.

This section details the functions that are associated with Port B. The function of the buttons at the bottom of the screen alternate between Port A and B when the leftmost button is clicked (**Port A/B**).

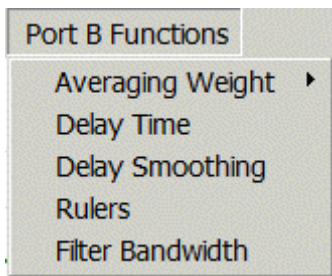

When measuring the transmission through a filter connected between Ports A and B, the amount of signal averaging used changes dynamically depending on the magnitude of the signal at Port B.

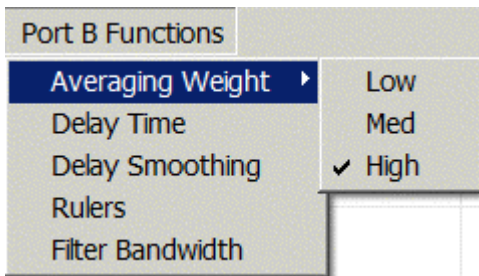

When a filter has high attenuation, the signal is weak and more averaging gives better results. The higher level of averaging takes more time, so there is a trade off between low noise in the reading and the scanning rate. For this reason, the highest level of averaging is only used during the portion of the scan when the signal level is low. The user can specify the rate at which the averaging level changes during a scan. When the Averaging Weight is Low, the averaging level is less and the scan rate is faster. When the Averaging Weight is High, the averaging level is greater for a better signal to noise ratio and the scan rate is slower.

Phase Delay compensation is used to offset a constant delay time through a filter or transmission line so that small variations are easier to see. The value can be nsec(n),

usec(u), or msec(m). The **Null button** enters an average value that is automatically calculated from the S21 phase data using the central data points.

Delay smoothing uses a running average to smooth the Group Delay data. This data tends to be noisy because it is the derivative of the phase shift with respect to frequency.

Two **horizontal rulers** can be specified for use with Port B functions. These typically will be used to specify the upper and lower levels for measuring the **bandwidth** of a filter. When both rulers are used, the **shape factor** of the filter is also calculated. The display of the rulers can be enabled or disabled without changing their value by clicking the box on the right side. When a new value is entered for a ruler, it is automatically enabled. The numeric values are in dB, (usually a negative number). A **response ratio** can be entered by following the number with the letter "x". For example, 0.5x will be converted to -6dB.

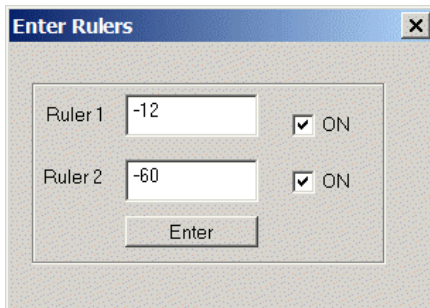

After scanning S21 for a filter, its bandwidth can be found at two levels specified by the rulers. First, position the vertical cursor near the center of the response curve. Then click "**Filter Bandwidth**" and the values at each level, along with the shape factor are displayed in a pop-up window. The points where the response curve crosses the rulers are indicated with colored dots. If desired, only one ruler can be used, in which case the shape factor will not be calculated.

The cursor can be frozen while selecting a menu item by pressing the left mouse button.

If the filter has ripple in the pass band, be sure the top ruler is below the ripple level.

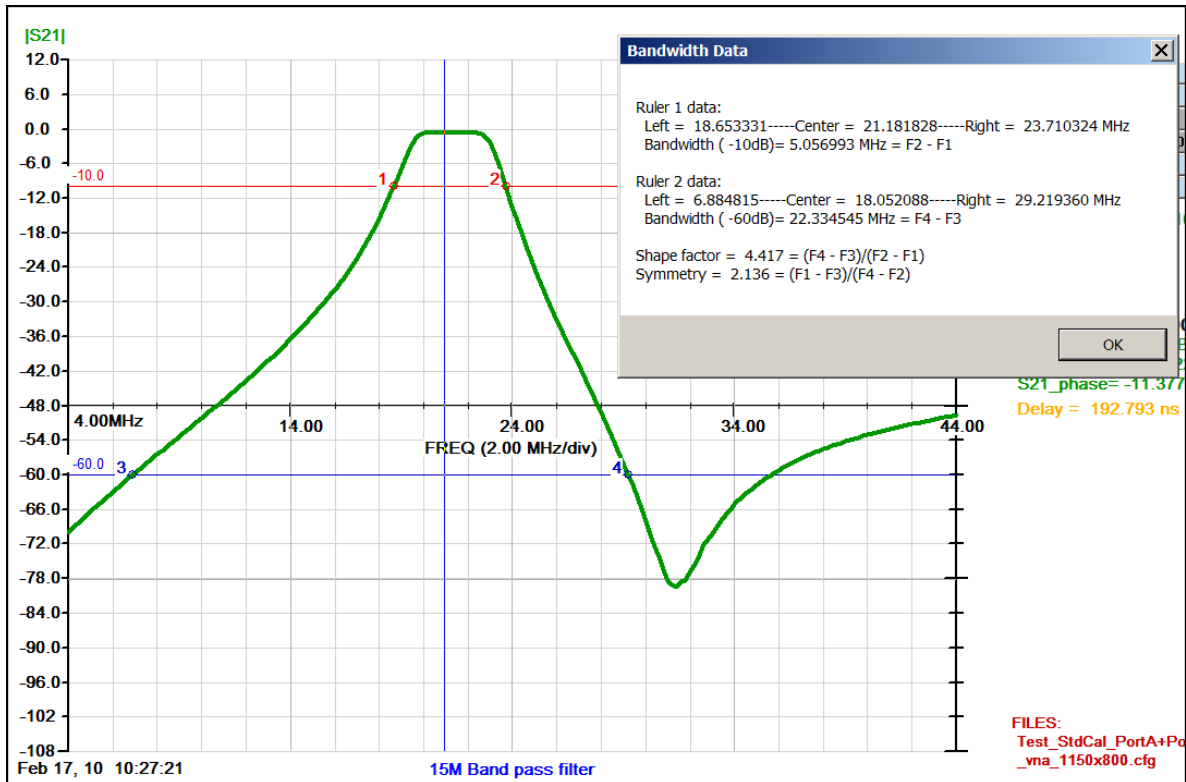

Measuring the bandwidth and shape factor of a band pass filter

The frequencies corresponding to the high and low limits where the response intersects the rulers are labeled **F1...F4**. These left and right frequencies and the **center frequencies** are shown in the bandwidth data window.

The **shape factor** is the ratio of the larger bandwidth to the smaller bandwidth.

A measure of **symmetry** is calculated by comparing the differences between the intersection points on the left and the right sides of the response curve. A perfectly symmetrical curve would have a measure = 1.0. Values greater than 1 indicate the low frequency tail is larger than the high frequency tail. Conversely, values less than 1 indicate the high frequency tail is larger.

The rulers can be changed and another bandwidth analysis can be done without having to scan the filter again.

Appendix 1 – VNA 2180 Specifications

Frequency Control: Digital Synthesizer 5KHz - 180 MHz ; Stability: +/- 30 ppm

Frequency Step Size: 1 Hz minimum

Calibration: software controlled (*no screwdriver adjustments*).

ADC resolution: 12 bits.

Measurement Ranges:

SWR: 1 to 20

Impedance: 1 ohm to 5K ohms

Accuracy: 1 ohm +/- 5% of reading up to 60 MHz
10% of reading up to 180 MHz

Phase Angle: +/-180 degrees (true phase)

S21 Transmission measurement nominal dynamic range: 100dB up to 50MHz, 80dB to 160MHz

Parameters displayed include: SWR, Reflection coefficient (S11), Return loss, Magnitude of load impedance, Phase angle of load impedance, S21, Equivalent series resistance and reactance, Equivalent parallel resistance and reactance. Reactance is shown as inductance (uH) or capacitance (pF) according to the phase angle.

Two Smith Chart displays with zoom, phase offset and markers.

Data can be referenced to the antenna terminals.

RF Output: +7 milliwatts max; Type N connector, driver nominal output impedance 50 ohms.

Spurious output: -30dBc or better

Max stray RF input while measuring: 2V peak (+16dBm)

Port B nominal input impedance 50 ohms. Return Loss better than 30dB.

Max safe RF input: 5V peak (+24dBm)

USB Interface, optically isolated.

Display: Graphics output on PC screen. Mouse controlled **cursor** for digital parametric readout. **Markers** for highlighting user specified frequencies. Audible **tone** and **speech** output for SWR to assist in making adjustments without watching the PC monitor.

Power Requirements: 11 to 15 VDC at 500mA max (120VAC power supply included)

Dimensions (approx): 7" x 5.3" x 1.5" (17.8 x 13.5 x 3.8 cm)

Software updates are available from www.w5big.com/vna2180.htm

Appendix 2 – Complex Numbers

A complex number has two parts: a real part that we are accustomed to using for most everyday problems, and an imaginary part. The imaginary part was introduced to handle the square root of negative numbers. In ordinary circumstances, any number squared is positive, so it seemed unreasonable for a negative number to have a square root. This was resolved by defining a special value called “the square root of minus one”. This is usually symbolized by “**i**” in math books and by “**j**” in engineering books. Using “**j**” avoids confusion in an engineering context with the symbol “**i**” that is usually used for current.

Complex numbers came into use about 500 years ago for solving algebraic equations, including the familiar second order equation: $ax^2 + bx + c = 0$.

(note: the symbol x^2 means “the value of x squared” = x times x .)

Let’s look at a specific example: $x^2 - x - 2 = 0$.

In this case the coefficients are: $a = 1$, $b = -1$, $c = -2$

The solutions using the quadratic equation are:

$$x = [- b + \text{SQRT}(b*b - 4ac)] / 2a$$

and

$$x = [- b - \text{SQRT}(b*b - 4ac)] / 2a$$

Inserting the coefficients of the equation, we get:

$$x = [1 + \text{SQRT}(1 + 8)] / 2 = 2$$

and

$$x = [1 - \text{SQRT}(1+8)] / 2 = -1$$

Now, if we go back and insert $x = 2$ into the equation, the equation is equal to zero and we also get zero by plugging in $x = -1$.

There is no problem here since we didn’t have to worry about the square root of a negative number.

A small change of one coefficient changes the mathematical problem considerably, as we will see now:

Let the equation be: $x^2 - x + 2 = 0$

$$a = 1, \quad b = -1, \quad c = +2$$

Changing “c” from -2 to $+2$ gives us:

$$x = [1 + \text{SQRT}(1 - 8)]/2$$

and

$$x = [1 - \text{SQRT}(1-8)]/2$$

Now we have to deal the problem of evaluating the square root of -7 .

We write this as: $-7 = (-1) * (+7)$

*Note the $\text{SQRT}(A*B) = \text{SQRT}(A)*\text{SQRT}(B)$, so $\text{SQRT}(-7) = \text{SQRT}(-1)*\text{SQRT}(+7)$.*

The $\text{SQRT}(+7)$ is 2.646 and $\text{SQRT}(-1)$ we define as “j”, so $\text{SQRT}(-7)=j*2.646$.

One solution to the equation is:

$$x = [1 + j2.646]/2 = 0.5 + j1.323$$

To confirm that the value $x=0.5+j1.323$ actually does cause the equation to equal zero, we have to do some arithmetic with complex numbers.

Addition is straightforward:

The real part of one number is added to the real part of the second number.

Similarly, the imaginary part of one number is added to the imaginary part of the second number.

$$(a + jb) + (c + jd) = (a+c) + j(b+d)$$

$$\text{For example: } (1 + j4) + (5 + j8) = (5+1) + j(4+8) = \underline{6 + j12}$$

Multiplication is a little tricky:

The two complex numbers have to be multiplied term by term:

$$(a+jb)*(c+jd) = a*c + jb*c + a*jd + jd*jb$$

We get 4 terms. Note that $j*j = -1$, so the last term = $-d*b$ (this is a real number)

The first and fourth terms are real, so we can add them directly to get: $(a*c - d*b)$

The second and third terms are imaginary, so we can them to get: $j*(b*c + a*d)$

The final result is:

$$(a+jb)*(c+jd) = (ac - db) + j(bc + ad)$$

This is tedious. Fortunately, the computer is good at this sort of thing, so we usually don't have to worry about the details.

Now we'll finish checking our equation by plugging in one of the answers that we found:

$$\text{Let } x = 0.5+j1.323$$

$$x*x = (0.5+j1.323)*(0.5+j1.323) = -1.50 + j1.323$$

$$\text{Then, the whole equation} = (-1.50+j1.323) - (0.5+j1.323) - 2 = 0 \quad (\text{good})$$

To relate complex numbers to electrical circuits, we make the following observations:

Resistance is a **real** number.

Inductive reactance is a positive **imaginary** number.

Capacitive reactance is a negative **imaginary** number.

The impedance of a circuit is:

$$Z = R + jX, \quad X = \text{reactance and it can be positive (inductor) or negative (capacitor)}$$

For example, suppose we have a 100pF capacitor (100×10^{-12} Farad) in series with a 500 ohm resistor and the frequency is 7 MHz.

$$\text{At 7 MHz, the capacitive reactance } X = -1/(2*\pi*7000000*100*10^{-12}) = -227 \text{ ohms}$$

*Note: the **minus** sign is very important.*

$$Z = 500 - j227 = \text{impedance of the series R-C circuit.}$$

$$\text{Real_part_of_Z} = \text{Re}(Z) = 500$$

$$\text{Imaginary_part_of_Z} = \text{Im}(Z) = -227$$

The magnitude of a complex number is the square root of the sum of the squares of the real part and the imaginary part:

$$\text{Magnitude_of_Z} = \text{SQRT}(500*500 + 227*227) = 549 \text{ ohms}$$

The phase angle, Phase, associated with this complex number can be calculated by:

$$\begin{aligned} \text{Phase} &= \text{ArcTangent}(\text{Imaginary_part} / \text{Real_part}) \\ &= \text{ArcTangent}(-227/500) = -24.4 \text{ degrees} \end{aligned}$$

The negative angle is characteristic of a capacitive circuit. It means the voltage is **trailing** (or lagging) the current. In an inductive circuit, the phase angle is positive since the voltage **leads** the current.

Appendix 3 – Hot Keys

The following keyboard keys can be used instead of clicking buttons with the mouse:

S – Scan (same as Scan button)

R – Rescan (same as Rescan button)

L – Enter new Limits (same as Limits button)

D – Get raw data in Point Data mode.

U – Do a scan and save the data in a file named \$AutoScan\$.csv for off-line processing by a program such as Excel.

Q – Exit the program

Left Arrow – Move the cursor to the left on the graph.

Right Arrow – Move the cursor to the right on the graph.

Up or Down Arrow – Swap the last two scans. (*either key can be used*)

Left mouse button – Disable the cursor movement (reverse this action with a flag in the Setup menu)

Right mouse button – Enter or delete markers.

Appendix 4 – USB Operation

The comm port assigned for USB operation can be found using the Windows **Device Manager**: Click Start → Settings → Control panel → System → Hardware → Device Manager.

It has been found that sometimes the computer operating system will say the USB driver is properly installed when it really isn't. Deleting the driver and then starting over and specifying that the driver must be reloaded from the CD may work. Sometimes, deleting the device manager for this port and then plugging the cable back into the computer will cause the PC to reinstall the correct driver.

The USB interface chip used in the VNA2180 is made by FTDI (www.ftdichip.com). The chip is called FT232R and the recommended driver for several versions of Windows is 2.04.16. A link to it is on this page: <http://www.ftdichip.com/Drivers/VCP.htm>

Check this web page for the latest information on the interface:
www.w5big.com/FAQ.htm

Appendix 5 – Expansion Port

An expansion port is provided for interfacing accessories. There are four digital I/O lines that can be specified as inputs or outputs in any combination during each I/O cycle and one analog input line that goes to the ADC so external voltages (0-3.3V) can be read. DC voltages are also available for small loads: 3.3V@50ma and 5V@100ma.

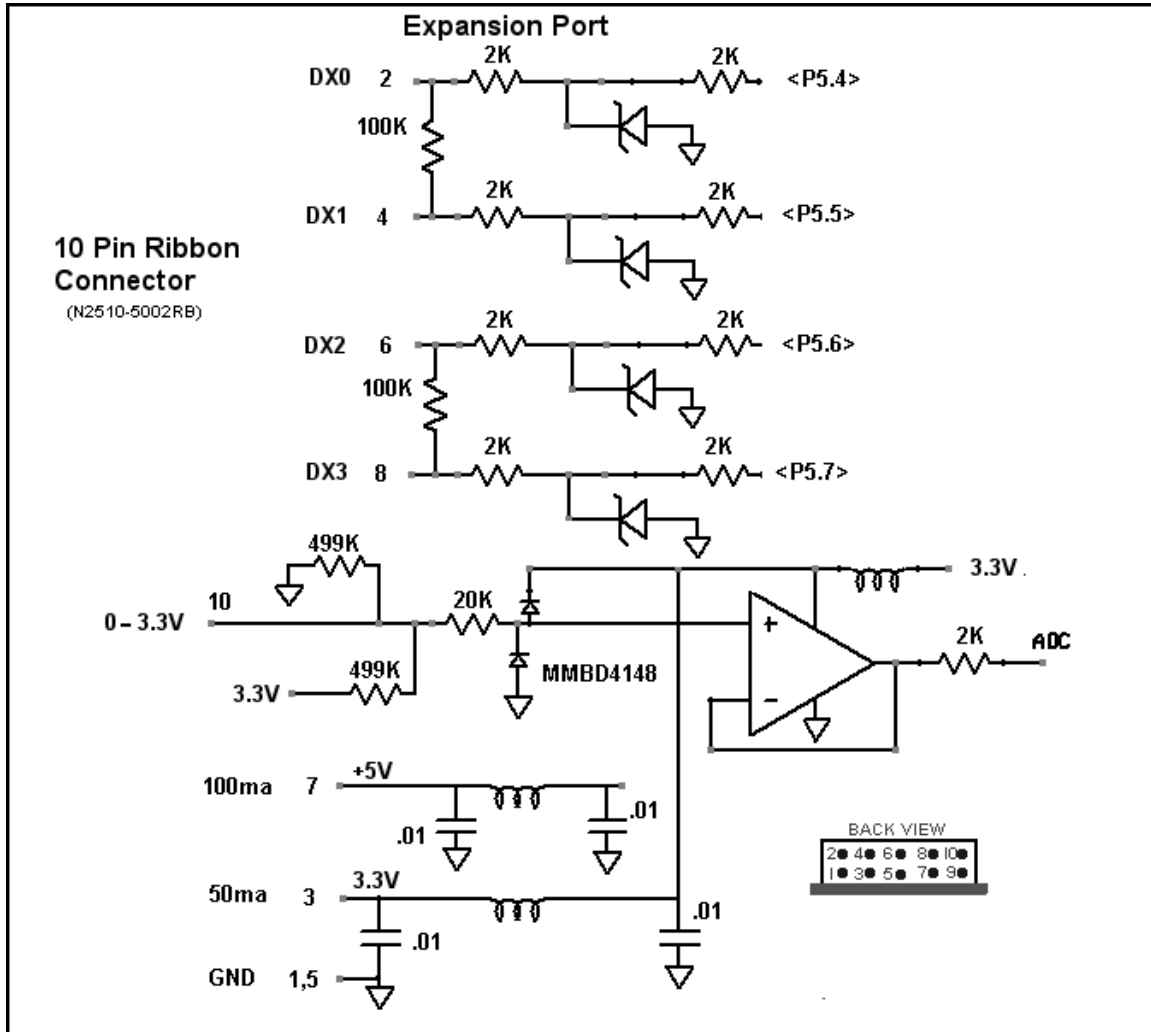

10 pin ribbon connector. 3M Part number: N2510-5002RB (the mating connector is available from Digikey)

PIN FUNCTION

- 1, 5 Ground
- 2 I/O LSB (0 to 3V, 4K source impedance)
- 4 I/O
- 6 I/O
- 8 I/O MSB
- 3 +3.3V @ 50ma
- 7 +5V @ 100ma
- 9 no connection
- 10 Analog input, 0 to 3.3V full scale (12 bit ADC)

The digital I/O pins can be programmed to be inputs or outputs on every cycle. There is a 4K resistor in series with them and zener diode clamp to protect the VNA circuits. If the input voltage goes above 4V or below -0.5V, the I/O pin has an impedance of 2K.

The inputs are protected up to +/-12 volts.

The analog input has an input impedance of 250K when the input voltage is between 0 and 3.3V and 20K when the diode clamps to +3.3V or ground are active. This input should be driven by a low impedance source. The full scale reading is 4095 (12 bits).

The +3.3V and +5V supply current is limited. If any significant current is needed, the external accessory should have its own regulator. The main +12V supply can be connected first to the accessory and then a daisy chain jumper from the accessory can supply the VNA so that only one power supply is needed.

The details of programming the expansion port have not been firmed up yet (*Sept. '09*). Basically, the sequence of operations will be in a script file that the user can create. The VNA program reads the script file and programs the I/O and reads the ADC.

The data format for each I/O cycle consists of three bytes. The data is in the 4 lower bits:

1. Direction code for each pin: 1=output, 0=input
2. Data per pin + readback_code, 1=ADC reading, 0=digital I/O.
If the msb of this byte is a zero, the data reading will correspond to digital data on the four I/O lines. If the msb is a 1, the two-byte reading will be the ADC reading corresponding to a full scale voltage of 3.3V.
3. Delay for settling in 100usec increments, 0 to 25msec

After programming the data, there is an optional wait for settling of the external circuits (relay open/close, analog signal settling, etc.).

Then the VNA will either read the digital I/O pins or the ADC will read the analog input. In either case two bytes of data are sent back to the PC. This data can be disregarded if the port is being used for output only.

Jan 7, '10 : These functions are still in a very flexible state and changes can be made for specific applications.

Appendix 6 - Battery Operation

The VNA2180 can be powered with a battery for portable operation. Battery voltage can range from 11.0 to 15V. The required current is approximately 350 mA when a measurement is in process and 300 mA when idle. The power can be turned off automatically after 10 minutes of inactivity if the Auto-Power-Off feature is enabled (this is an option in the SETUP menu at the top of the screen).

A conventional 12V gel cell is a suitable battery for extended operation. The easiest way to connect the battery is to use a barrel connector like the wall power supply uses. This is a 5.5x2.1mm barrel connector. The Mouser part number is: 1710-2120. An extra cable is provided with the standard VNA2180 kit. This has wire leads on one end which can be connected to any type of battery terminals desired.

When using the VNA2180 to test a mobile antenna on a motor vehicle, it is better to use a separate battery and **not** the 12V battery in the vehicle. A small 12V battery will power the unit for several hours. This avoids the problem of sneak paths through the ground between the DC power input and the antenna ground connection. It will also help reduce measurement noise if it's necessary to run the engine while taking data (such as to operate the air conditioner). **If it's essential to get power for the VNA2180 from the vehicle, be sure to put 1 amp fuses in BOTH the +12V lead and the power ground lead.** A small voltage drop across the fuses will not affect the VNA2180 since the battery voltage is much more than the required minimum operating voltage. The laptop computer being used should remain **floating** for the best measurement accuracy.

J6 is the power connector mounted on the rear panel. The wall power supply (or external battery) plugs in here. D1 and D11 are a cross-over circuit to select either the external or internal power source, whichever is more positive. The battery positive and negative connections are labeled on the pc board.

R54 is an optional resistor for trickle-charging a rechargeable battery. This is a user-selected resistor. It is not included in the VNA2180 but there is a space on the PCB for mounting a through-hole resistor.

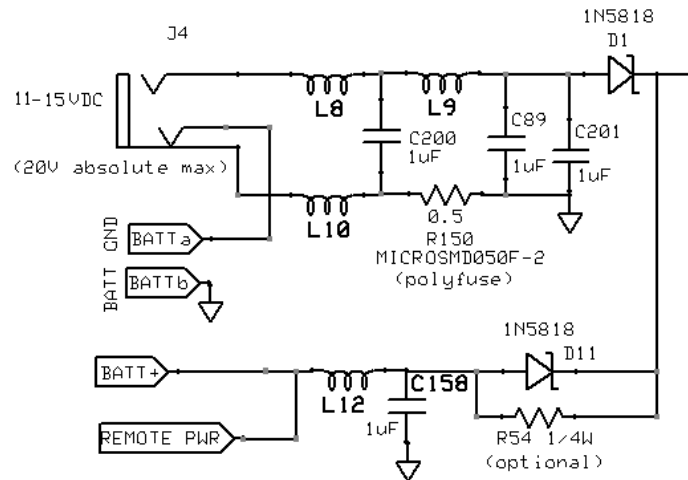

Appendix 7 – Saving Screen Shots

Pictures of the scan can be very useful for documentation. A nice **freeware** utility that makes this process easy is called “**PrintScreen**” from Gadwin:

<http://www.gadwin.com/printscreens/>

This utility installs very easily. It can save the whole screen, the current window (the one with its top banner highlighted), or a rectangular area that you can select. For saving shots of the VNA data, the *current window* is probably the most useful choice. This should be saved in **gif** format, not jpg. Gif format saves a better quality **graphic image** and it usually takes fewer bytes than jpg. (jpg is better for photographs.)

You can also save the screen in .bmp format by clicking: **File ->Save Image Bitmap**

Screen shots can be saved with a conventional **paint program**. The first step is to copy the screen image to the clipboard by pressing the **ALT** key and then the **Print Screen** key. This will transfer the **active** window to the clipboard. If you want to copy the entire screen, just press the **Print Screen** key.

The screen image can be inserted into a program, such as **Microsoft Word, Paintshop** or **Paint Shop Pro** by pressing **Control-V**.

The Windows operating system also includes a standard accessory program called “**Paint**” that’s already available on all computers.

To run “**Paint**”, click the **Start** button in the lower left corner of the screen.

Then click “**Programs**”

Scroll to find “**Accessories**”

Click “**Paint**”

Click **Control-V** to insert the screen shot into the working page.

Then save the file as a **.gif** or **.jpg**. (.gif is preferable since the quality of the line drawing in gif format is better than it is in jpg)

Now your screen shot can be inserted into a **document file** (*.doc) or **attached to an email**.

The new versions of Windows include a **Snipping Tool** which can be used to grab portions of a screen and save it. Click the **Start Button** in the lower left corner of the screen to find the Snipping Tool.

Appendix 8 – Configuration File

The file shown in the following pages may not be exactly the same as the latest version. For details, refer to the config file that came with the latest version of your program.

The configuration file (*.cfg) is used to set the screen colors and some other operating parameters. Several different config files can be resident in the same folder. They are selected using the menu option: **File -> Load Config File.**

The following comments are included in the config file itself. The exact content of the config file changes from time to time, so the latest file may be somewhat different from the text below.

```

=====
This is a comment line that is displayed when the config file is loaded from the menu.
// The user-supplied comment above will be displayed when the config is loaded from the
// menu.
// The comment line does not have to start with the // symbols.
// There can be several config files in the same folder. The comment in the first line is
// helpful to differentiate them.

// April 23, 2006
// VNA configuration file
// The parameters must remain in the same sequence.
// When new parameters are added, they will be placed at the end of the file.

// Comments or blank lines can be inserted freely.
// Comments are indicated by a double-slash //
// The double-slash should start in column 1.
// If the config file is not found in the same folder as the exe file,
// default values will be used.

// COLORS for PLOTTING:
// Colors are entered as RED, GREEN, BLUE with values 0-255
// 0=no color, 255=maximum color (max red, max green, or max blue)
// Examples: 0,0,0 = black (no red, no green, no blue)
//           255,255,255=white (max red, max green, max blue)
//           255,0,0=bright red   0,255,0=bright green   0,0,255=bright blue

// The included utility file: colors.exe can be used to help select the colors.
// The numbers should be in decimal format.

```

// A space or comma can be used to separate the three numbers.

// Only the first number (or set of 3 numbers for colors) on each line is used.

// The rest of the line is a comment.

// A double-slash on a line means the whole line is a comment.

// When experimenting with colors, the new set of colors can be entered on the same
// line and the old ones are pushed to the right.

// The old ones will be ignored by the program but they are handy for reference.

// There are two sets of colors for each parameter:

// The brighter color is used for the main scan (first scan)

// A fainter shade of that color is used for the rescan (second scan)

// The actual colors can be changed by using the color

// palette under the Setup -> Graph Styles menu. If you want to change these defaults,

// use the editor under the Help menu.

240,0,0 RED=SWR (or reflection coefficient) main scan and Smith Chart trace

240,120,0 light red=SWR (or reflection coefficient) rescan

0,200,0 Green=Zmagnitude main scan

130,240,180 light green=Zmagnitude rescan

200,0,200 Magenta=Phase main scan

200,180,240 light magenta=Phase rescan

0,200,200 Cyan=vertical cursor that is moved with the mouse.

64,122,252 Blue=Return Loss main scan

160,160,250 light blue=Return Loss rescan

200,200,0 Yellow=Xs or Xp (whichever is selected) main scan

255,255,0 light yellow=Xs or Xp rescan

255,174,0 Orange=Rs or Rp main scan

255,195,125 light orange=Rs or Rp rescan

250,250,200 smbackground=Smith Chart background color

230,230,230 grid color=color of gridlines on the graph

200, 0, 0 file name color (cal,config,cable_cal file names displayed on screen)

// Cursor enable:

1 = (default) cursor is enable whether left mouse button is pressed or not.

// (0 means cursor is enabled only when left mouse button is pressed.)

// Graph line width:

2 = Line width of the plotted data (can be 1,2,3,4,5)

// Halt:

2 = Halt if right mouse button is pressed)

// (0 = Halt if Halt button at bottom of screen is clicked)

//

// BAND SELECTION: Start_freq, Stop_freq, Step_freq (all in MHz)

// The actual "Stop_freq" on the graph will be equal to or greater than the

// value specified here.

// The frequencies specified DO NOT have to correspond to ham radio bands.

// The frequencies and the step freq can be any value within the range of the VNA.

// The comma should follow immediately after the start_freq and stop_freq values. (no space)

// The string after "station=" is a user supplied string to IDENTIFY the band

// on the menu. It can be up to 12 characters long but it cannot have any spaces.

// (Use an underline or a dash character instead of a space.)

1.7, 2.1, 0.01, station=160_meters all of these values can be user specified.

3.4, 4.1, 0.02, station=80_meters

5.3, 5.50, 0.005, station=60_meters

6.9, 7.4, 0.01, station=40_meters

10.1, 10.20, 0.005, station=30_meters

13.9, 14.5, 0.01, station=20_meters

18.0, 18.20, 0.005, station=17_meters

20.9, 21.6, 0.01, station=15_meters
24.7, 25.1, 0.01, station=12_meters
27.9, 29.8, 0.05, station=10_meters
49.5, 54.5, 0.10, station=6_meters
143.5,148.5, 0.10, station=2_meters
1.00, 150.00, 2.0, station=Band_A (Bands A..D are not highlighted on the graph)
1.00, 21.00, 0.2, station=Band_B
5.00, 45.00, 0.25, station=Band_C
13.00, 43.00, 0.2, station=Band_D
230,230,245 245,245,245 // highlight color for the ham frequency bands on graph
100000 max number of data points. This can range from 20 to 100K.
0 meters/feet (1 means use meters as default length, 0 means use feet as default)
500 Max delay in milliseconds for external hardware
// to respond to the USB data link. (for example, Bluetooth)
// Parameters to set graph and font sizes:
// If the max width and height are larger than the actual screen size,
// the full screen size will be use.
// The earlier versions of the VNA program used a max graph size of 950 x 600.
978 (no longer used in the VNA) max graph width in pixels
600 (no longer used in the VNA) max graph height in
7 Default font size. 5 is very small, 6 and 7 are medium, 8 is large.
// minimum font value=3, maximum font value=10
1 Bold Data display (0=not bold data)
1.00 Smith Chart size factor. The size factor limits are: 3x to 0.5x The width and height are always the same
0 Do not clear each screen during recycle mode (0=don't clear, 1= do clear)

300 Delay in milliseconds while recycling. Several seconds may be useful in some cases.

1 1 means RS232=115K, 0 means RS232=57.6K, May have to use "0" for Bluetooth

0 issue cal warning if long stub is attached while calibrating

2.0 parameter 3

0.3 parameter 4

32 xtal averaging

1 external program control: 1=disable 2=enable-don't display counter, 3=enable & show counter

1 auto save graph after each scan, 0=don't save

// The next two lines are path names for the external control input and output files:

// The names controlfile= and outputfile= must appear first on the line.

// The exact position on the line is not critical.

// The file and path names can be anything, they don't have to be on the C drive.

// Don't enclose the path name in quotes.

// Use double back-slashes for folder delimiters.

// The path names CANNOT have spaces in them. Use dashes or underscores.

// All valid filename characters are ok except spaces.

controlfile= C:\\temp\\datafile1.txt input control file initiates scan

outputfile= C:\\temp\\AutoScan.csv output data csv file

// Voice output parameters:

voicefilefolder=Sounds_1\\ Folder for voice sounds (wav files)

1 num_digits=1 or 2 in fractional part for voice output

0 0=Don't repeat the same number, 1=Repeat the same number.

1 parameter_10

// if Zmag changes too much between data points, issue an alert:

4 = Freq resolution tolerance as a percentage of full scale, e.g, 4=4% of full scale, 5=5%, 10=10%, etc.

// the alert can be made less sensitive by entering a larger number, e.g., 100 will disable it.

// The data will be valid even when the alert appears.

// END of config file

Appendix 9 – Component Test Fixture

The VNA2180 can be used to measure small discrete components over a specified frequency range. A convenient way to hold them is with a BNC to binding post adapter. Even though the adapter has significant stray capacitance and inductance, these stray parameters can be cancelled by the calibration procedure. The adapter shown here is from Jameco, part number 99355, which costs about \$5.30 in the U.S.A.

(ref: www.jameco.com)

When calibrating, insert a piece of wire between the binding posts for the **short circuit**. Then remove the wire for the **open circuit**. The **resistor** that is used can be any 1/4W or 1/8W carbon or metal film resistor with an accurately known value. A resistor in the range of 50 to 500 ohms can be used.



For testing very small surface mount components, another adapter can be made from a small piece of printed circuit board material. A cut down the middle isolates the two sides. A similar cut is also made on the back side if the printed circuit board has copper on both sides. Two heavy wires (#16 - #20) can be used to connect it to the binding posts. The chip component being tested can be held securely by pressing it against the board with the eraser of a pencil or a plastic screwdriver.



Here we see the surface mount adapter combined with the binding post adapter. The stray capacitance of this combination adapter will also be compensated by the calibration procedure. Capacitors in the picofarad to nanofarad range and inductors in the nanohenry to microhenry range can be measured.

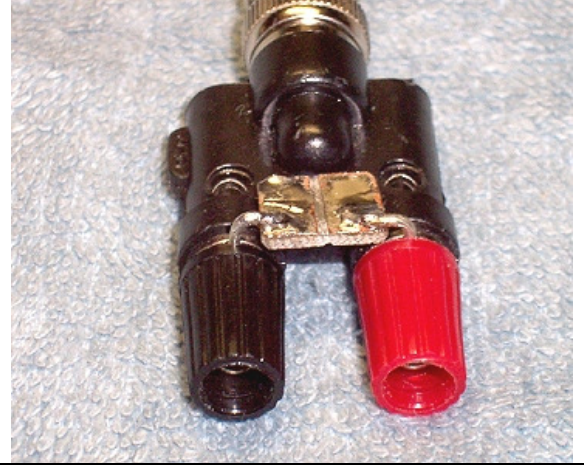

Appendix 10 – External Program Control

The VNA2180 can be integrated with a test system so that measurements are done under the control of a “**Master**” program. A new procedure has been incorporated in program version 514 which is more robust than the earlier version.

By using this procedure, the calibration and data processing in the VNA program are employed automatically and the user can focus on analyzing the final data that is output to a file in CSV (comma separated values) format. This file can be read by Excel or the user's custom program.

The Master program communicates with the VNA by data strings in the registry. The scan data from the VNA is written to a CSV file in the same format that it was before.

The four parameters sent from the Master to the VNA are: **Start_freq**, **End_freq**, **Delta_freq** and **ScanPort**. The frequency values are in megahertz. After these parameters are written to the registry, the VNA will read them, perform the scan and write the csv file. It then puts the name of the csv data file in the registry so the Master knows the scan is complete and the data is ready.

To enable external control, set the flag in the config file to 2 or 3:

3 external program control: 1=disable 2=enable-don't display time, 3=enable & show time

If the flag is set to "3", a one second timer is displayed in the upper left corner of the screen.

The names of the registry key and data file are specified in the VNA config file:

**controlfile= hkey_current_user\software\AIMVNA\ : input control key initiates scan (this is new in
: VNA version 514 and later)**

outputfile= C:\temp\AutoScan.csv : output data csv file

A sample file called "External_Control.eba" is included with the zipped VNA files to illustrate the communication process. A compiled version of this sample program can be run to get a feel for how the process works.

While the VNA is in the external control mode, the other features operate normally. It still responds to mouse and keyboard commands.

Appendix 11 - Voice Output

The SWR value can be sounded out verbally in the **Point Data Mode**. This feature is enabled using the **Setup menu -> Voice Output**. This makes it possible to make adjustments without looking at the computer monitor. It's also possible to send the readings to another location using telephones, cell phones or portable radios. For example, the VNA can be located in the lab and you can hear the SWR readings while up on a tower.

The numbers are saved in **wav** files. Each number is a separate file. The program breaks up the swr reading into its separate digits and plays the appropriate wav file for each digit. For example, the number one is a file called: **one.wav**. The number two is a file called: **two.wav**, etc. The decimal point is a file called **point.wav**. There are 11 separate files. These are in a folder whose name is specified in the config file. The default folder is **sounds_1** but the name can be anything you like. It has to be a subfolder of the folder where the program is located. By changing the folder name, you can have different sets of files with different voices and different languages. The content of the wav file does not matter at all, only the name is use by the VNA program.

There is an option in the config file to select either one or two digits for the fractional part of the reading. Using a single fraction digit will make the repetition rate faster.

Another config file option controls **repeating** the same reading. For example, if the swr reading is a steady 1.25, you may not want to listen to this over and over. If the flag is zero, the same reading will not be repeated twice in a row. If this flag is some value greater than **zero**, the same reading will be repeated every **Nth** pass. For example, if the flag is equal to 5, the same reading will be repeated after 5 measurements. Larger or smaller numbers can be used too. This way you can tell if the system is still working, even when the reading doesn't change for a long time.

To get started, I made the wav files myself. This leaves a lot of room for improvement. I'm sure some people can improve on the quality of these files and perhaps share them with other VNA users. Since the wav files are completely independent of the VNA program, it's not hard to create a new set in a new folder. Then change the folder name in the config file. With the menu option: **Help -> Edit Config File** you can switch between voice file sets quickly. If you're interested in an audio editor, try www.wavosaur.com.

Appendix 12 - Band Skipping

When testing a multiband antenna, the scanning process can be speeded up by jumping over the spaces between the bands of interest. The bands to be scanned are defined in the config file in the same format that is already being used. On one line, there are three numbers: Start_freq, End_freq, Delta_freq. These are in **MHz**. The Start and End frequencies define a particular band that will be scanned. These values do not have to correspond to a ham band. When scanning a ham band, the entire band does not have to be scanned. You can scan just the CW band or the phone band if you want to.

The calibration procedure, either standard or custom cal, is not affected at all by band skipping. The custom cal procedure (if used) is performed at all the frequencies between the Start and End points. The only difference is that raw data points are not read at frequencies between the selected bands during a scan. Therefore, the whole freq range can be covered in much less time.

The **Start** and **End** frequencies for the scan are set by clicking the **Limits** button. The **Step size** is specified here and the delta_freq in the config file is not used. All bands are scanned with the same frequency step size, regardless of the value in the config file.

After setting up the Start and End frequencies, go to the **Bands menu** and click on **Band Skip**. This flag will alternate between on/off each time you click it. There will be a check mark beside Band Skip when it is enabled.

To compare the performance with and without skipping, first highlight the bands. Then click on Scan for a regular scan. Now set Band Skip and click Rescan. The whole scan over the bands of interest will be much faster and the data inside the highlighted bands will be essentially the same as before, when skipping was off.

Markers can be very helpful when adjusting multiband antennas or filters. The SWR for each band can be displayed by analog gauges which make it easier to visualize when the optimum points are reached. See the Marker section of this manual for details.

Appendix 13 - DSP Filters

DSP filters 1 & 2 - A distant station on the same channel may cause a small but noticeable disturbance of the scan where you want to make a measurement. This interference can often be eliminated by using the DSP filters.

These filters have two parameters: **center frequency** & **scan width**. The **center frequency** does not have to correspond exactly to the point where the noise is centered. Also, there can be more than one burst of noise in the scan range. Typically the scan range will be small, no more than 100KHz for signals in the AM broadcast band and up to 1MHz in the FM band. The scan range is specified by its **half-width**. The scan will be between f1 and f2 corresponding to the center frequency minus the half-width and the center frequency plus the half-width. The numbers can be entered in kilohertz by following them with a “**K**” or “**k**”.

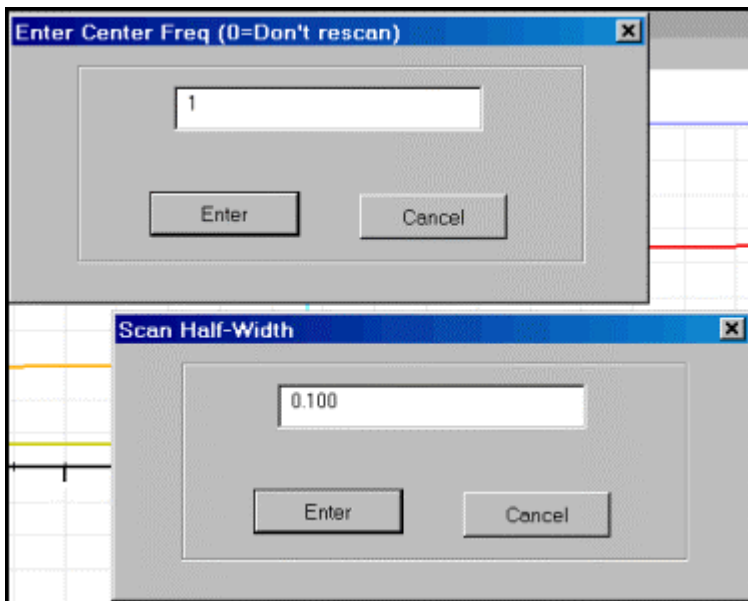

If 0.0 is entered for the center frequency, the DSP filter will process the data already in memory from a previous scan. This is useful for processing data saved in scan files. Otherwise, a new scan will be done with the specified scan limits and this new data will be processed.

The two filters use different techniques and one may work better than the other, depending on the situation. The calculated data will be superimposed using a heavy line over the original data so you can see its effect. The new trace can be displayed by itself by clicking on a function that causes the display to be refreshed, for example, click the **scales button** and then **enter**.

(the following screen shots were made using a PowerAIM, the filter processing in the VNA2180 is the same)

An example is shown below using DSP filter 1:

ORIGINAL SCAN:

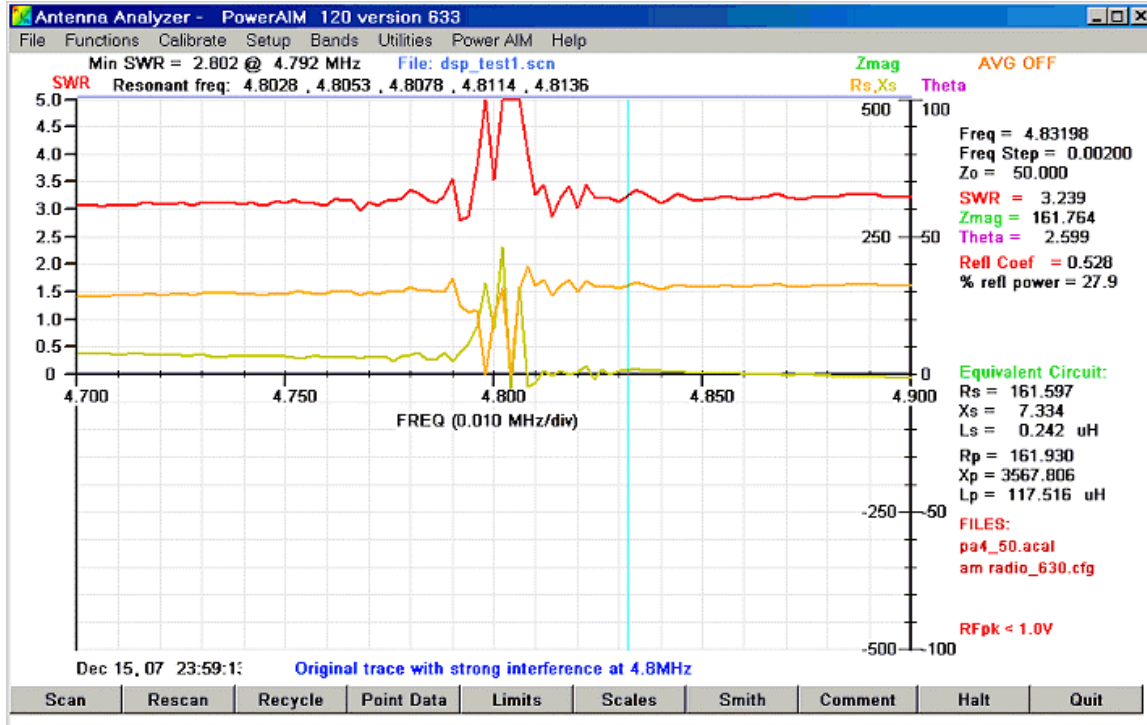

AFTER PROCESSING WITH DSP FILTER 1:

(heavy lines are new data after filtering)

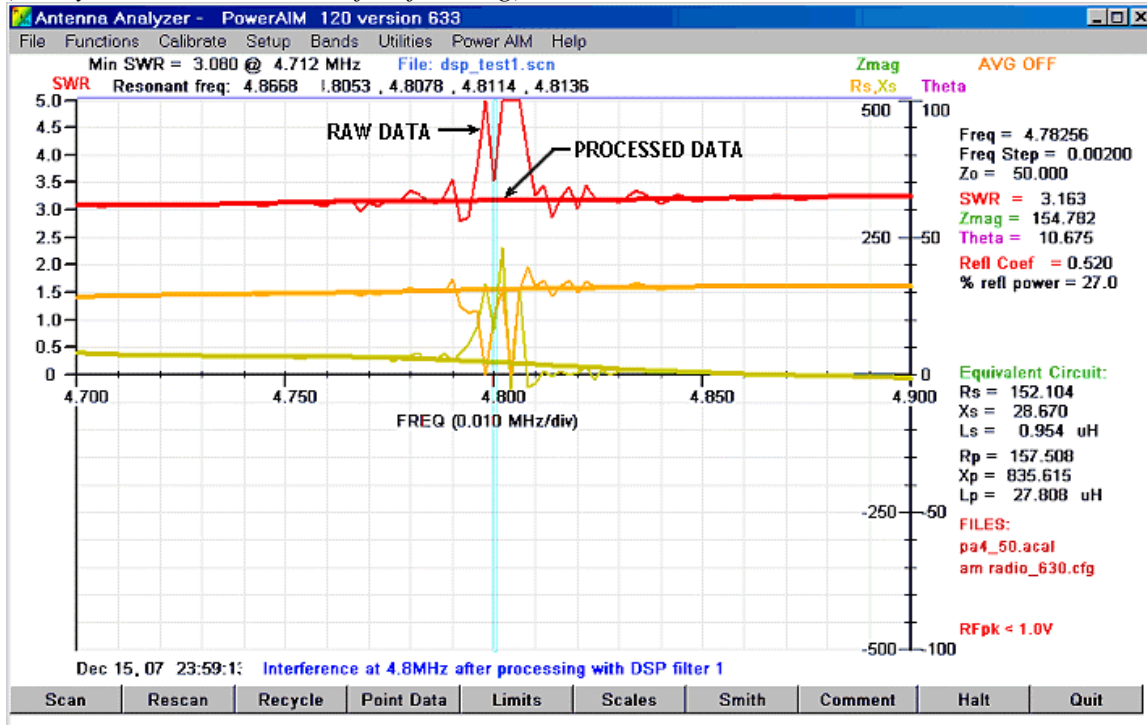

In the example above, the heavy, highlight lines are shown so it's easier to see the effect of the filter. Red corresponds to SWR, orange to Rseries and yellow to Xseries.

Below are two screen shots showing the effect of using DSP filter 2. The interfering signal in this scan was injected using a transmitter feeding one antenna while scanning another nearby antenna.

ORIGINAL SCAN:

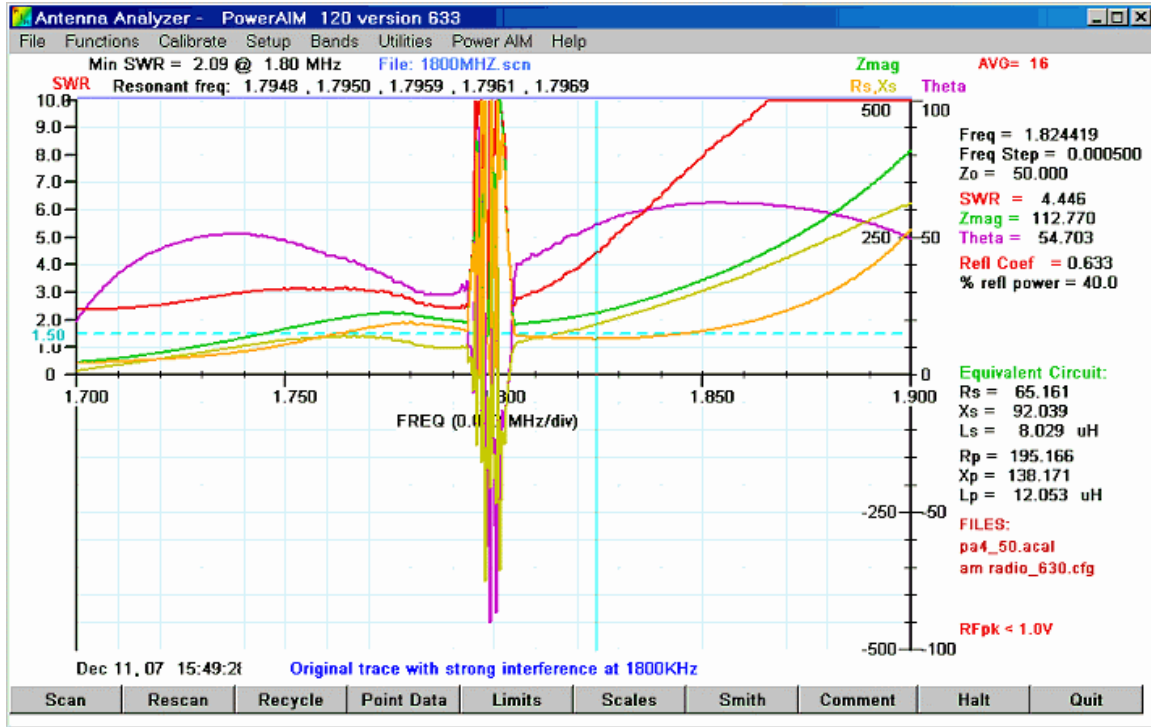

AFTER PROCESSING WITH DSP FILTER 2:

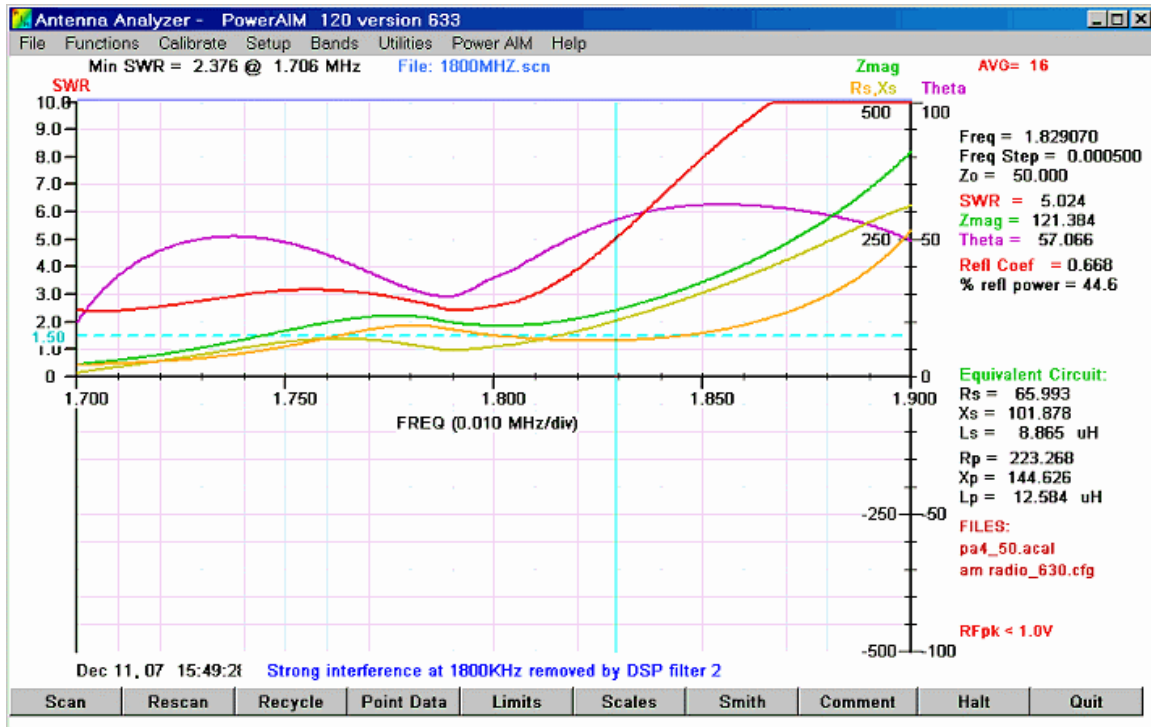

Terms and Conditions

ORDERING: visit our on-line store at www.arrayolutions.com/pricelist.htm or phone us at (972) 203-2008 (9:00-4:00 CST) to order. More information on ordering is shown below.

UPGRADES: Software upgrades are available at no cost. This includes programs for both the analyzer controller and the PC.

Check the website: w5big.com/prog_update.htm for the latest version of the program and the latest application information.

POLICIES AND WARRANTIES:

Products Manufactured By Array Solutions - Limited Warranty

The warranty on the VNA2180 and related models is two years. We warrant the functioning of the product as designed. If it fails to function as designed, we will repair or replace it free of charge as long as you, the original purchaser, own it and it was not damaged from lightning, other act of God or other casualty. We reserve the right to make that determination. We will photograph the evidence of such non-covered damage and will be happy to show it to you. We will listen to any reasonable argument on your behalf to alter our opinion and do our best to reach a mutually agreeable solution. You must pay for shipping charges both to and from us.

Procedure for Obtaining Warranty Service

If you have any doubts as to whether a problem is with our product or somewhere else in your system, please call us at our below listed telephone number. No one else besides us is authorized to perform our warranty obligations. If you are sure the problem is with our product, just ship it to our factory address. Please follow the packaging procedure explained below under "ALL REPAIRS." We will not make a warranty repair unless you include a copy of your purchase receipt, so please include it with the product to be repaired.

This warranty gives you specific legal rights, and you may also have other rights that vary from state to state.

Products Not Manufactured By Array Solutions - Manufacturer's Warranty Only

We do not warrant other products we sell. They are warranted by the original manufacturer. Please follow the manufacturer's policies and procedures for warranty service to insure the best and quickest service.

Provisions Applicable to All Products

Very Important, retain all shipping boxes for possible claims made to the shipper for damaged product! Not doing so will affect how your warranty replacement is handled since we cannot replace a product that had its damage claim rejected due to the customer not retaining the original shipping box.

In no case will we be liable for any incidental or consequential damages, which includes, but is not limited to, damage to equipment connected or attached to any product we sell. Some states do not allow the exclusion or limitation of incidental or consequential damages, so the above limitation or exclusion may not apply to you.

Your sole and exclusive remedy upon our failure to meet our warranty obligations to repair or replace as described above is refund of the purchase price.

ANY CONTROVERSEY OR CLVNA ARISING OUT OF OR RELATING TO PRODUCTS WE SELL SHALL BE SETTLED BY ARBITRATION IN ACCORDANCE WITH THE ARBITRATION RULES OF THE AMERICAN ARBITRATION ASSOCIATION.

You may obtain warranty information at no charge by calling us at the below telephone number or by contacting the manufacturer for products we do not manufacture.

OTHER THAN AS STATED ABOVE, ARRAY SOLUTIONS DISCLAIMS ANY WARRANTY OF MERCHANTABILITY, FITNESS FOR ANY PARTICULAR PURPOSES WHATSOEVER AND ANY IMPLIED WARRANTIES.

ALL REPAIRS: When sending in a product for service, please carefully "double" box it and ship it insured for your protection. Please include a note clearly describing the problem, how you wish the item returned to you and how you wish to pay for the service if it is not covered by our warranty. Package your item properly. Array Solutions is not responsible for merchandise damaged in shipment. Our service rate is \$50 per hour (2 hr. minimum).

NON-REPAIR RETURNS: Returned items must be received by us in original, as-shipped, condition including the original box, manuals, accessories, and copy of sales receipt. Returns must be within 14 days of purchase. Returned items are subject to a 15% restocking fee. Shipping charges are not refundable.

Phone and FAX:

Tel: 972 203 2008

Fax: 972 203 8811

Factory Address: Array Solutions
2611 N. Beltline #109
Sunnyvale, TX 75182

Sales Outside the United States: Purchase of products by those outside the United States of America constitutes purchaser's agreement that all questions concerning the respective rights and obligations arising under the terms of purchase are subject to arbitration under the provisions of Texas Civil Practice and Remedies Code Section 172.001 et seq.

On Line: Ordered on line. Our secure, dedicated server is one of the fastest and protected with 128-bit encryption. You can be sure of your privacy.

PAYMENT: We accept Visa, Mastercard, money orders, cashiers checks and personal checks, and bank transfers. Phone order customers please be ready to provide card number, expiration, issuing bank, billing and shipping address plus home & work phone (e-mail customers please provide this information also). We request this information for your protection. Money orders, cashiers checks and personal checks may require 2 weeks to clear from un-established customers and/or large purchases.

MINIMUM ORDER: We have no minimum. Your order is important to us whether it is for \$5 or \$500.

SHIPPING of Array Solutions Stocked Products: We ship most orders within 5 business days (UPS Next Day and Second Day Air orders are shipped within 24 hours). We ship Monday through Friday. Our normal method of shipment is UPS Surface International orders are sent with Air mail parcel post or EMS. We do not ship C.O.D. Array Solutions reserves the right at any time after receipt of your order to accept or decline your order for any reason. You may request shipment by other means such as FedEx, UPS Next Day Air, UPS Second Day Air or Air Freight for export orders. Equipment is packed very carefully and sent insured. Please provide us with a full shipping address. UPS cannot ship to a Post Office box.

Shipping of ICE Products is usually shipped to you Factory Direct from ICE. ICE ship dates vary extensively due to customer demand and products in stock at their facility. We cannot be held liable for the ship date of their products, but we will try to expedite the order if we are told by you that you need it by a certain date. Please order these products early.

PRICES: Prices and specifications are subject to change! We are not responsible for typographical errors.

SALES TAX: Array Solutions shall automatically charge and withhold the applicable sales tax (8.25%) for orders to be delivered to addresses within the state of Texas. Each customer shall be solely responsible for all sales taxes, or other taxes, on orders shipped outside Texas.

FOREIGN ORDERS: Foreign orders must be payable in U.S. dollars. You may use Visa, Mastercard, postal money order or bank check drawn on a U.S. bank with transit numbers imprinted on bottom of the check or bank transfer to our account. We will supply you our banking information upon request. The customer is responsible for shipping on warranty

service. We do our best to deliver to you using the more expensive EMS (Express Mail Service) parcel post which allows us a tracking number to follow up if there is a problem. We have experienced some long deliveries to certain countries like Spain, Portugal, Italy and some South American countries. We may insist on using a shipping service such as UPS, DHL, FEDEX, or Freight Forwarder for certain countries or large orders due to past losses in your country.

SHIPPING TO Array Solutions: When you ship your equipment for service it is important that it is packaged properly. Use the original box and packing material if possible. If you do not have the original box, wrap the equipment well with bubble wrap then place this in a box with adequate packing material. All equipment should then be placed in a second box with packing material to help ensure its safe arrival to us. Please be sure to insure your package for its value. Array Solutions will not be responsible for equipment that is damaged in shipment to us.

CUSTOMER INFORMATION: Array Solutions does not sell, rent, lease or trade customer information with any other company.

LIMITATIONS OF LIABILITY: Except as expressly stated herein, Array Solutions makes no representations or warranties, either express or implied, of any kind with respect to products sold on the Array Solutions website, including but not limited to, merchantability and fitness for a particular purpose. You agree that the sole and exclusive maximum liability that Array Solutions has arising from any product sold on the Array Solutions web site shall be the price of the product ordered. In no event shall Array Solutions, its directors, officers, employees or other representatives be held liable for special, indirect, consequential, or punitive damages related to products sold.

RETURNS: Returned items must be received in the original condition including the program CD, power supply, cable, and accessory connectors. Returns must be within fourteen days of receipt. If the original box is not available, suitable boxes can be obtained from the post office without charge. Use the original packing materials if available or the equivalent. For maximum protection of your equipment, insure the package and request a signature when it is received. Shipping cost is not refundable. We will pay the return shipping for warranty repairs.

WARRANTY SERVICE: Products have a one year limited warranty. This includes parts and labor. We will repair or replace the unit at our discretion.

<p>CIRCUITS AND PROCEDURES used by this vector impedance measurement system are covered by one or more patents pending.</p>
